



DEEP SEA ELECTRONICS PLC DSE4510 & DSE4520 Operator Manual

Document Number: 057-171

Author: Fady Atallah

DEEP SEA ELECTRONICS PLC

Highfield House
 Hunmanby
 North Yorkshire
 YO14 0PH
 ENGLAND



Sales Tel: +44 (0) 1723 890099
 Sales Fax: +44 (0) 1723 893303

E-mail: sales@deepseapl.com
 Website: www.deepseapl.com

DSE4510 & DSE4520 Operator Manual

© Deep Sea Electronics Plc

All rights reserved. No part of this publication may be reproduced in any material form (including photocopying or storing in any medium by electronic means or other) without the written permission of the copyright holder except in accordance with the provisions of the Copyright, Designs and Patents Act 1988.

Applications for the copyright holder's written permission to reproduce any part of this publication should be addressed to Deep Sea Electronics Plc at the address above.

The DSE logo is a UK registered trademarks of Deep Sea Electronics PLC.

Any reference to trademarked product names used within this publication is owned by their respective companies.

Deep Sea Electronics Plc reserves the right to change the contents of this document without prior notice.

Amendments List

Issue	Comments	Minimum Module version required	Minimum Configuration Suite Version required
1	Initial release	V1.0.0	2013.25 V1.97.50
2	Added FPE item 11 – Display ph-ph	V1.0.0	
3	Added alarm icon and FPE item changes	V1.4.0	2013.21 v1.93.3.0
4	Removal of part numbers	NA	NA

Typeface: The typeface used in this document is *Arial*. Care should be taken not to mistake the upper case letter I with the numeral 1. The numeral 1 has a top serif to avoid this confusion.

Clarification of notation used within this publication.



	NOTE	Highlights an essential element of a procedure to ensure correctness.
	CAUTION!	Indicates a procedure or practice, which, if not strictly observed, could result in damage or destruction of equipment.
	WARNING!	Indicates a procedure or practice, which could result in injury to personnel or loss of life if not followed correctly.

TABLE OF CONTENTS

Section	Page
1 BIBLIOGRAPHY	6
1.1 INSTALLATION INSTRUCTIONS	6
1.2 TRAINING GUIDES	6
1.3 MANUALS	6
1.4 THIRD PARTY DOCUMENTS	6
2 INTRODUCTION.....	7
3 SPECIFICATIONS.....	8
3.1 SHORT NAMES.....	8
3.2 OPERATING TEMPERATURE.....	8
3.3 REQUIREMENTS FOR UL CERTIFICATION.....	8
3.4 TERMINAL SPECIFICATION	9
3.5 POWER SUPPLY REQUIREMENTS	9
3.5.1 MODULE SUPPLY INSTRUMENTATION DISPLAY	9
3.6 VOLTAGE & FREQUENCY SENSING	10
3.7 CURRENT SENSING.....	10
3.7.1 VA RATING OF THE CTS.....	11
3.7.2 CT POLARITY.....	12
3.7.3 CT PHASING	12
3.7.4 CT CLASS	12
3.8 INPUTS.....	13
3.8.1 DIGITAL INPUTS	13
3.8.2 ANALOGUE INPUTS	13
3.8.2.1 OIL PRESSURE.....	13
3.8.2.2 COOLANT TEMPERATURE	13
3.8.2.3 FUEL LEVEL SENSOR.....	14
3.8.2.4 FLEXIBLE SENSOR (WHEN CONFIGURED).....	14
3.8.3 CHARGE FAIL INPUT.....	14
3.9 OUTPUTS.....	15
3.9.1 DC OUTPUTS A & B (FUEL & START).....	15
3.9.2 CONFIGURABLE DC OUTPUTS C & D.....	15
3.9.3 CONFIGURABLE DC OUTPUTS E & F (DSE4520 ONLY).....	15
3.10 COMMUNICATION PORTS	15
3.10.1 COMMUNICATION PORT USAGE	15
3.10.1.1 CAN INTERFACE	15
3.10.1.2 USB CONNECTION.....	16
3.11 ADDING AN EXTERNAL SOUNDER	17
3.12 ACCUMULATED INSTRUMENTATION	17
3.13 DIMENSIONS AND MOUNTING	18
3.13.1 DIMENSIONS	18
3.13.2 PANEL CUTOUT.....	18
3.13.3 WEIGHT	18
3.13.4 FIXING CLIPS.....	19
3.13.5 SILICON SEALING GASKET	20
3.13.6 APPLICABLE STANDARDS.....	21
3.13.7 ENCLOSURE CLASSIFICATIONS.....	23
3.13.7.1 IP CLASSIFICATIONS	23
3.13.7.2 NEMA CLASSIFICATIONS	24
4 INSTALLATION	25
4.1 TERMINAL DESCRIPTION	25
4.1.1 DC SUPPLY, FUEL AND START OUTPUTS, OUTPUTS C, D, E & F.....	26
4.1.2 ANALOGUE SENSOR	27
4.1.3 CONFIGURABLE DIGITAL INPUTS & CAN.....	28

4.1.4	GENERATOR / MAINS VOLTAGE & FREQUENCY SENSING.....	28
4.1.5	GENERATOR CURRENT TRANSFORMERS.....	29
4.1.5.1	CT CONNECTIONS.....	29
4.1.6	PC CONFIGURATION INTERFACE CONNECTOR.....	30
4.2	TYPICAL WIRING DIAGRAM.....	31
4.2.1	DSE4510 TYPICAL WIRING DIAGRAM (3 PHASE 4 WIRE).....	32
4.2.2	DSE4520 TYPICAL WIRING DIAGRAM (3 PHASE 4 WIRE).....	33
4.3	ALTERNATE TOPOLOGY WIRING DIAGRAMS.....	34
4.3.1	GENERATOR.....	34
4.3.2	MAINS (4520 ONLY).....	35
4.4	EARTH SYSTEMS.....	36
4.4.1	NEGATIVE EARTH.....	36
4.4.2	POSITIVE EARTH.....	36
4.4.3	FLOATING EARTH.....	36
5	DESCRIPTION OF CONTROLS.....	37
5.1	CONTROL PUSH-BUTTONS.....	38
5.2	MODULE DISPLAY.....	39
5.2.1	INSTRUMENTATION ICONS.....	40
5.2.2	ACTIVE CONFIGURATION.....	41
5.2.3	FRONT PANEL EDITOR (FPE) / AUTO RUN ICON.....	41
5.2.4	MODE ICON.....	41
5.2.5	LOAD SWITCHING ICON.....	42
5.2.6	BACKLIGHT.....	42
5.2.7	ALARM ICONS (PROTECTIONS).....	43
5.2.7.1	WARNING ALARM ICONS.....	44
5.2.7.2	ELECTRICAL TRIP ALARM ICONS.....	45
5.2.7.3	SHUTDOWN ALARM ICONS.....	46
5.3	VIEWING THE INSTRUMENT PAGES.....	48
5.3.1	NAVIGATION MENU.....	48
5.3.1.1	NAVIGATION MENU ICONS.....	48
5.3.2	GENERAL NAVIGATION.....	49
5.3.3	HOME.....	50
5.3.4	GENERATOR.....	50
5.3.5	MAINS (DSE4520 ONLY).....	51
5.3.6	LOAD.....	51
5.3.7	ENGINE.....	52
5.3.8	INFO.....	52
5.3.9	ENGINE DTC (ECU ALARMS).....	53
5.3.9.1	VIEWING ACTIVE ENGINE DTC.....	53
5.3.10	EVENT LOG.....	55
5.3.10.1	VIEWING THE EVENT LOG.....	55
6	OPERATION.....	56
6.1	QUICKSTART GUIDE.....	56
6.1.1	STARTING THE ENGINE.....	56
6.1.2	STOPPING THE ENGINE.....	57
6.2	STOP/RESET MODE.....	58
6.3	AUTOMATIC MODE.....	59
6.3.1	WAITING IN AUTO MODE.....	59
6.3.2	STARTING SEQUENCE.....	59
6.3.3	ENGINE RUNNING.....	59
6.3.4	STOPPING SEQUENCE.....	60
6.4	MANUAL/START MODE.....	61
6.4.1	WAITING IN MANUAL MODE.....	61
6.4.2	STARTING SEQUENCE.....	61
6.4.3	ENGINE RUNNING.....	62
6.4.4	STOPPING SEQUENCE.....	62
6.5	MAINTENANCE ALARM.....	63
6.6	SCHEDULER.....	64

6.6.1	STOP MODE	64
6.6.2	MANUAL/START MODE	64
6.6.3	AUTO MODE	64
7	FRONT PANEL CONFIGURATION.....	65
7.1	ACCESSING THE FRONT PANEL CONFIGURATION EDITOR.....	66
7.2	ADJUSTABLE PARAMETERS.....	67
7.2.1	MODULE SETTINGS	67
7.2.2	CAN SETTINGS.....	67
7.2.3	INPUT SETTINGS	68
7.2.4	OUTPUT SETTINGS.....	69
7.2.5	TIMER SETTINGS	69
7.2.6	GENERATOR SETTINGS.....	70
7.2.7	MAINS SETTINGS.....	71
7.2.8	ENGINE SETTINGS.....	72
7.2.9	ANALOGUE INPUTS SETTINGS.....	73
7.2.10	SCHEDULER SETTINGS.....	74
7.2.11	TIME AND DATE SETTINGS.....	74
7.2.12	MAINTENANCE ALARM SETTINGS.....	75
7.2.13	ALTERNATE CONFIGURATION SETTINGS.....	75
7.3	SELECTABLE PARAMETER SETTINGS	77
7.3.1	INPUT SOURCES	77
7.3.2	OUTPUT SOURCES.....	78
7.3.3	ALARM ACTION	80
7.3.4	FLEXIBLE SENSOR ALARM ACTION	80
7.3.5	POWER UP MODE.....	80
7.3.6	SENSOR TYPE.....	80
7.3.7	AC SYSTEM	80
7.3.8	DIGITAL INPUT ALARM ARMING	81
7.3.9	DIGITAL INPUT POLARITY	81
7.3.10	DIGITAL OUTPUT POLARITY	81
7.3.11	FUEL UNITS	81
7.3.12	PRESSURE SENSOR LIST	82
7.3.13	TEMPERATURE SENSOR LIST	82
7.3.14	PERCENTAGE SENSOR LIST	82
8	COMMISSIONING.....	83
9	FAULT FINDING.....	84
9.1	STARTING	84
9.2	LOADING	84
9.3	ALARMS.....	85
9.4	COMMUNICATIONS.....	85
9.5	INSTRUMENTS	85
9.6	MISCELLANEOUS	86
10	MAINTENANCE, SPARES, REPAIR AND SERVICING	87
10.1	PURCHASING ADDITIONAL CONNECTOR PLUGS FROM DSE.....	87
10.1.1	PACK OF PLUGS	87
10.1.2	INDIVIDUAL PLUGS	87
10.2	PURCHASING ADDITIONAL FIXING CLIPS FROM DSE.....	87
10.3	PURCHASING ADDITIONAL SEALING GASKET FROM DSE.....	87
11	WARRANTY.....	88
12	DISPOSAL	88
12.1	WEEE (WASTE ELECTRICAL AND ELECTRONIC EQUIPMENT).....	88
12.2	ROHS (RESTRICTION OF HAZARDOUS SUBSTANCES).....	88

1 BIBLIOGRAPHY

This document refers to and is referred to by the following DSE publications which can be obtained from the DSE website: www.deepseapl.com

1.1 INSTALLATION INSTRUCTIONS

Installation instructions are supplied with the product in the box and are intended as a 'quick start' guide only.

DSE Part	Description
053-145	DSE4510 & DSE4520 Installation Instructions

1.2 TRAINING GUIDES

Training Guides are produced to give 'handout' sheets on specific subjects during training sessions

DSE Part	Description
056-005	Using CTs With DSE Products
056-010	Over Current Protection
056-022	Breaker Control
056-029	Smoke Limiting
056-030	Module PIN Codes

1.3 MANUALS

Product manuals are can be downloaded from the DSE website: www.deepseapl.com

DSE Part	Description
057-004	Electronic Engines and DSE Wiring Guide
057-172	DSE45xx Configuration Suite PC Software Manual

1.4 THIRD PARTY DOCUMENTS

The following third party documents are also referred to:

Reference	Description
ISBN 1-55937-879-4	IEEE Std C37.2-1996 IEEE Standard Electrical Power System Device Function Numbers and Contact Designations. Institute of Electrical and Electronics Engineers Inc
ISBN 0-7506-1147-2	Diesel generator handbook. L.L.J. Mahon
ISBN 0-9625949-3-8	On-Site Power Generation. EGSA Education Committee.

2 INTRODUCTION

This document details the installation and operation requirements of the DSE4510 & DSE4520 modules, part of the DSE Genset® range of products.

The manual forms part of the product and should be kept for the entire life of the product. If the product is passed or supplied to another party, ensure that this document is passed to them for reference purposes.

This is not a *controlled document*. You will not be automatically informed of updates. Any future updates of this document will be included on the DSE website at www.deepseapl.com

The DSE4xx series is designed to provide differing levels of functionality across a common platform. This allows the generator OEM greater flexibility in the choice of controller to use for a specific application.

The DSE45xx series module has been designed to allow the operator to start and stop the generator, and if required, transfer the load to the generator either manually or automatically. Additionally, the DSE4520 automatically starts and stops the generator set depending upon the status of the mains (utility) supply.

The user also has the facility to view the system operating parameters via the LCD display.

The DSE45xx module monitors the engine, indicating the operational status and fault conditions, automatically shutting down the engine and giving a true first up fault condition of an engine failure by the LCD display.

The powerful ARM microprocessor contained within the module allows for incorporation of a range of complex features:

- *Icon based LCD display*
- **True RMS Voltage**
- *Current and Power monitoring (Not applicable to the DSE45xx-01 variant)*
- *USB Communications*
- *Engine parameter monitoring.*
- *Fully configurable inputs for use as alarms or a range of different functions.*
- *Engine ECU interface to **electronic engines**.*

Using a PC and the DSE Configuration Suite software allows alteration of selected operational sequences, timers, alarms and operational sequences. Additionally, the module's integral front panel configuration editor allows adjustment of this information.

A robust plastic case designed for front panel mounting houses the module. Connections are via locking plug and sockets.

Access to critical operational sequences and timers for use by qualified engineers, can be protected by a security code. Module access can also be protected by PIN code. Selected parameters can be changed from the module's front panel.

The module is housed in a robust plastic case suitable for panel mounting. Connections to the module are via locking plug and sockets.

3 SPECIFICATIONS

3.1 SHORT NAMES

Short Name	Description
DSE4000,DSE4xxx	All modules in the DSE4000 range.
DSE4500,DSE45xx	All modules in the DSE4500 range.
DSE4510	DSE4510 module/controller
DSE4520	DSE4520 module/controller

3.2 OPERATING TEMPERATURE

Module	Description
DSE45xx	-30°C to +70°C (-40°C to +70°C for variants fitted with display heaters)

3.3 REQUIREMENTS FOR UL CERTIFICATION

Screw Terminal Tightening Torque	<ul style="list-style-type: none"> • 4.5 lb-in (0.5 Nm)
Conductors	<ul style="list-style-type: none"> • Terminals suitable for connection of conductor size 12 AWG – 26 AWG (0.5mm² to 2.0mm²). • Conductor protection must be provided in accordance with NFPA 70, Article 240 • Low voltage circuits (35 volts or less) must be supplied from the engine starting battery or an isolated secondary circuit. • The communication, sensor, and/or battery derived circuit conductors shall be separated and secured to maintain at least ¼" (6mm) separation from the generator and mains connected circuit conductors unless all conductors are rated 600 Volts or greater.
Current Inputs	<ul style="list-style-type: none"> • Must be connected through UL Listed or Recognized isolating current transformers with the secondary rating of 5A max.
Communication Circuits	<ul style="list-style-type: none"> • Must be connected to communication circuits of UL Listed equipment
Output Pilot Duty	<ul style="list-style-type: none"> • 0.5 A
Mounting	<ul style="list-style-type: none"> • Suitable for use in type 1 Enclosure Type rating with surrounding air temperature -22°F to +158°F (-30°C to +70°C) • Suitable for pollution degree 3 environments when voltage sensing inputs do not exceed 300V. When used to monitor voltages over 300V device to be install in an unventilated or filtered ventilation enclosure to maintain a pollution degree 2 environment.
Operating Temperature	<ul style="list-style-type: none"> • -22°F to +158°F (-30°C to +70°C)
Storage Temperature	<ul style="list-style-type: none"> • -40°F to +176°F (-40°C to +80°C)

3.4 TERMINAL SPECIFICATION

NOTE: For purchasing additional connector plugs from DSE, please see the section entitled **Maintenance, Spares, Repair and Servicing** elsewhere in this document.

Connection Type	Two part connector. <ul style="list-style-type: none"> • Male part fitted to module • Female part supplied in module packing case - Screw terminal, rising clamp, no internal spring. 	 <p>Example showing cable entry and screw terminals of a 10 way connector</p>
Minimum Cable Size	0.5mm ² (AWG 24)	
Maximum Cable Size	2.5mm ² (AWG 10)	

3.5 POWER SUPPLY REQUIREMENTS

Minimum Supply Voltage	8V continuous
Cranking Dropouts	Able to survive 0V for 100ms providing the supply was at least 10V before the dropout and recovers to 5V afterwards.
Maximum Supply Voltage	35V continuous (60V protection)
Reverse Polarity Protection	-35V continuous
Maximum Operating Current	96mA at 12V 85mA at 24V
Maximum Standby Current	51mA at 12V 47mA at 24V
Maximum Current When In Sleep Mode	35mA at 12V 32mA at 24V
Maximum Current When In Deep Sleep Mode	Less than 10µA at 12V Less than 10µA at 24V

3.5.1 MODULE SUPPLY INSTRUMENTATION DISPLAY

Range	0V-70V DC (note Maximum continuous operating voltage of 35V DC)
Resolution	0.1V
Accuracy	1% full scale (±0.7V)

3.6 VOLTAGE & FREQUENCY SENSING

Measurement Type	True RMS conversion
Sample Rate	5kHz or better
Harmonics	Up to 11 th or better
Input Impedance	300k Ω phase to neutral
Phase To Neutral	15V (minimum required for sensing frequency) to 415V AC (absolute maximum) Suitable for 345V nominal ($\pm 20\%$ for under/overvoltage detection)
Phase To Phase	25V (minimum required for sensing frequency) to 720V AC (absolute maximum) Suitable for 600V nominal ($\pm 20\%$ for under/overvoltage detection)
Common Mode Offset From Earth	100V AC (max)
Resolution	1V AC phase to neutral 2V AC phase to phase
Accuracy	$\pm 1\%$ of full scale phase to neutral $\pm 2\%$ of full scale phase to phase
Minimum Frequency	3.5 Hz
Maximum Frequency	75.0 Hz
Frequency Resolution	0.1 Hz
Frequency Accuracy	± 0.2 Hz

3.7 CURRENT SENSING

 **NOTE: Current Sensing is not available on the DSE45xx-01 variant.**

Measurement Type	True RMS conversion
Sample Rate	5KHz or better
Harmonics	Up to 10 th or better
Nominal CT Secondary Rating	5A
Maximum Continuous Current	5A
Overload Measurement	3 x Nominal Range setting
Absolute Maximum Overload	50A for 1 second
Burden	0.25VA (0.01 Ω current shunts)
Common Mode Offset	± 1 V peak plant ground to CT common terminal
Resolution	0.5% of 5A
Accuracy	$\pm 1\%$ of Nominal (5A) (excluding CT error)

3.7.1 VA RATING OF THE CTS

The VA burden of the module on the CTs is 0.5VA. However depending upon the type and length of cabling between the CTs and the module, CTs with a greater VA rating than the module are required.

The distance between the CTs and the measuring module should be estimated and cross-referenced against the chart opposite to find the VA burden of the cable itself.

If the CTs are fitted within the alternator top box, the star point (common) of the CTs should be connected to system ground (earth) as close as possible to the CTs. This minimises the length of cable used to connect the CTs to the DSE module.

Example.

If 1.5mm² cable is used and the distance from the CT to the measuring module is 20m, then the burden of the cable alone is approximately 15VA. As the burden of the DSE controller is 0.5VA, then a CT with a rating of at least 15+0.5V = 15.5VA must be used. If 2.5mm² cables are used over the same distance of 20m, then the burden of the cable on the CT is approximately 7VA. CT's required in this instance is at least 7.5VA (7+0.5).

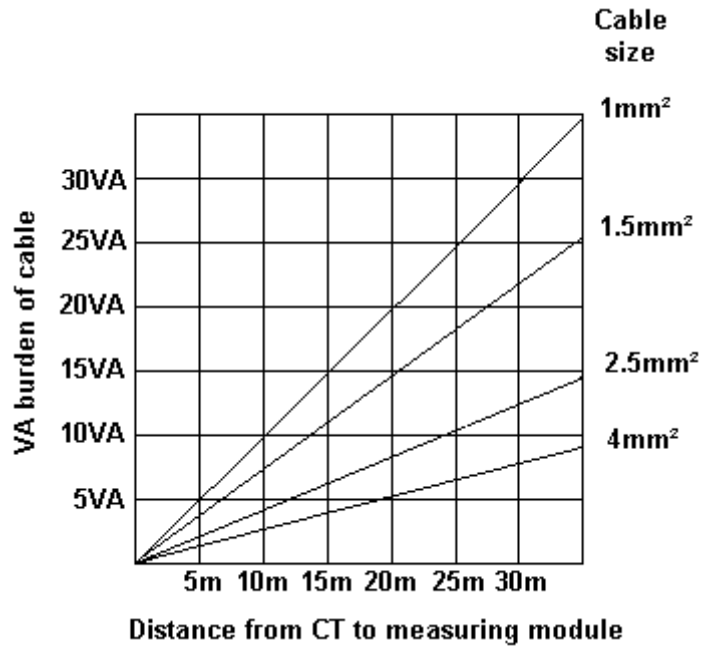

NOTE: Details for 4mm² cables are shown for reference only. The connectors on the DSE modules are only suitable for cables up to 2.5mm².

3.7.2 CT POLARITY

NOTE: Take care to ensure correct polarity of the CT primary as shown above. If in doubt, check with the CT supplier.

Take care to ensure the correct polarity of the CTs. Incorrect CT orientation will lead to negative kW readings when the set is supplying power. Take note that paper stick-on labels on CTs that show the orientation are often incorrectly placed on the CT (!). It is more reliable to use the labelling in the case moulding as an indicator to orientation (if available).

To test orientation, run the generator in island mode (not in parallel with any other supply) and load the generator to around 10% of the set rating. Ensure the DSE module shows positive kW for all three individual phase readings.

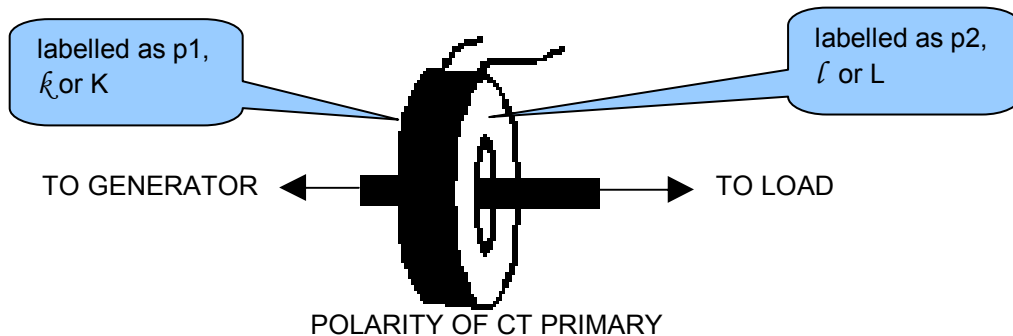

3.7.3 CT PHASING

Take particular care that the CTs are connected to the correct phases. For instance, ensure that the CT on phase 1 is connected to the terminal on the DSE module intended for connection to the CT for phase 1.

Additionally ensure that the voltage sensing for phase 1 is actually connected to generator phase 1. Incorrect connection of the phases as described above will result in incorrect power factor (pf) measurements, which in turn results in incorrect kW measurements.

One way to check for this is to make use of a single-phase load. Place the load on each phase in turn, run the generator and ensure the kW value appears in the correct phase. For instance if the load is connected to phase 3, ensure the kW figure appears in phase 3 display and not in the display for phase 1 or 2.

3.7.4 CT CLASS

Ensure the correct CT type is chosen. For instance if the DSE module is providing overcurrent protection, ensure the CT is capable of measuring the overload level you wish to protect against, and at the accuracy level you require.

For instance, this may mean fitting a protection class CT (P10 type) to maintain high accuracy while the CT is measuring overload currents.

Conversely, if the DSE module is using the CT for instrumentation only (current protection is disabled or not fitted to the controller), then measurement class CTs can be used. Again, bear in mind the accuracy you require. The DSE module is accurate to better than 1% of the full-scale current reading. To maintain this accuracy you should fit Class 0.5 or Class 1 CTs.

You should check with your CT manufacturer for further advice on selecting your CTs

3.8 INPUTS

3.8.1 DIGITAL INPUTS

Number	4 configurable digital inputs (7 when Analogue Inputs are configured as digital inputs)
Arrangement	Contact between terminal and ground
Low Level Threshold	3.2V minimum
High Level Threshold	8.1V maximum
Maximum Input Voltage	+60V DC with respect to plant supply negative
Minimum Input Voltage	-24V DC with respect to plant supply negative
Contact Wetting Current	6mA typical
Open Circuit Voltage	15V typical

3.8.2 ANALOGUE INPUTS

3.8.2.1 OIL PRESSURE

Measurement Type	Resistance measurement by measuring voltage across sensor with a fixed current applied
Arrangement	Differential resistance measurement input
Measurement Current	11mA \pm 10%
Full Scale	240 Ω
Over Range / Fail	270 Ω
Resolution	0.1 Bar (1-2 PSI)
Accuracy	\pm 2% of full scale resistance (\pm 4.8 Ω) excluding transducer error
Max Common Mode Voltage	\pm 2V
Display Range	0 bar - 17.2 bar (0PSI - 250PSI) subject to limits of the sensor

3.8.2.2 COOLANT TEMPERATURE

Measurement Type	Resistance measurement by measuring voltage across sensor with a fixed current applied
Arrangement	Differential resistance measurement input
Measurement Current	11mA \pm 10%
Full Scale	480 Ω
Over Range / Fail	540 Ω
Resolution	1°C (2°F)
Accuracy	\pm 2% of full scale resistance (\pm 9.6 Ω) excluding transducer error
Max Common Mode Voltage	\pm 2V
Display Range	0°C - 250°C (32°F - 482°F) subject to limits of the sensor

3.8.2.3 FUEL LEVEL SENSOR

Measurement Type	Resistance measurement by measuring voltage across sensor with a fixed current applied
Arrangement	Differential resistance measurement input
Measurement Current	11mA \pm 10%
Full Scale	480 Ω
Over Range / Fail	540 Ω
Resolution	1%
Accuracy	+/-2% of full scale resistance (\pm 9.6 Ω) excluding transducer error
Max Common Mode Voltage	\pm 2V
Display Range	0% - 250% subject to limits of the sensor

3.8.2.4 FLEXIBLE SENSOR (WHEN CONFIGURED)

Number	1 when <i>Fuel Level Sender</i> is configured as a flexible
Measurement Type	Resistance measurement by measuring voltage across sensor with a fixed current applied
Arrangement	Differential resistance measurement input
Measurement Current	11mA \pm 10%
Full Scale	480 Ω
Over Range / Fail	540 Ω
Resolution	1%
Accuracy	+/-2% of full scale resistance (\pm 9.6 Ω) excluding transducer error
Max Common Mode Voltage	\pm 2V
Display Range	0% - 250%, 0°C - 250°C (32°F - 482°F) or 0 bar - 17.2 bar (0PSI - 250PSI)subject to limits of the sensor and sensor configuration

3.8.3 CHARGE FAIL INPUT

Minimum Voltage	0V
Maximum Voltage	35V (plant supply)
Resolution	0.2V
Accuracy	\pm 1% of max measured voltage
Excitation	Active circuit constant power output
Output Power	2.5W nominal at 12V and 24V
Current At 12V	210mA
Current At 24V	105mA

The charge fail input is actually a combined input and output. Whenever the generator is required to run, the terminal provides excitation current to the charge alternator field winding.

When the charge alternator is correctly charging the battery, the voltage of the terminal is close to the plant battery supply voltage. In a failed charge situation, the voltage of this terminal is pulled down to a low voltage. It is this drop in voltage that triggers the *charge failure* alarm. The level at which this operates and whether this triggers a warning or shutdown alarm is configurable using the DSE Configuration Suite Software.

3.9 OUTPUTS

3.9.1 DC OUTPUTS A & B (FUEL & START)

Type	Normally used as Fuel & Start outputs. Fully configurable for other purposes if the module is configured to control an electronic engine.
Rating	10A resistive for 10secs, 5A resistive continuous at 35V

3.9.2 CONFIGURABLE DC OUTPUTS C & D

Type	Fully configurable, supplied from DC supply terminal 2.
Rating	2A resistive continuous at 35V

3.9.3 CONFIGURABLE DC OUTPUTS E & F (DSE4520 ONLY)

Type	Fully configurable, supplied from DC supply terminal 2.
Rating	2A resistive continuous at 35V

3.10 COMMUNICATION PORTS

USB Port	USB 2.0 Device for connection to PC running DSE configuration suite only. Max distance 6m (18 yards)
CAN Port	Engine CAN Port Standard implementation of 'Slow mode', up to 250K bits/s Non-Isolated. Internal Termination provided (120Ω) Max distance 40m (133 feet)
 NOTE: For additional length, the DSE124 CAN Extender is available. For more information, refer to DSE Publication: 057-116 DSE124 Operator Manual	

3.10.1 COMMUNICATION PORT USAGE

3.10.1.1 CAN INTERFACE

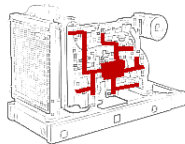

Modules are fitted with the CAN interface as standard and are capable of receiving engine data from engine CAN controllers compliant with the CAN standard.

CAN enabled engine controllers monitor the engine's operating parameters such as engine speed, oil pressure, engine temperature (among others) in order to closely monitor and control the engine. The industry standard communications interface (CAN) transports data gathered by the engine controller interface. This allows generator controllers to access these engine parameters with no physical connection to the sensor device.

 **NOTE: For further details on connection to electronic engines, refer to DSE Publication: 057-004 Electronic Engines And DSE Wiring**

3.10.1.2 USB CONNECTION

The USB port is provided to give a simple means of connection between a PC and the controller. Using the DSE Configuration Suite Software, the operator is then able to control the module, starting or stopping the generator, selecting operating modes, etc.

Additionally, the various operating parameters (such as output volts, oil pressure, etc.) of the remote generator are available to be viewed or changed.

To connect a module to a PC by USB, the following items are required:

- DSE45xx Controller
- DSE Configuration Suite PC Software (Supplied on configuration suite software CD or available from www.deepseapl.com).
- USB cable Type A to Type B.
(This is the same cable as often used between a PC and a USB printer)



DSE can supply this cable if required :
PC Configuration interface lead (USB type A – type B) DSE
Part No 016-125

NOTE: The DC supply must be connected to the module for configuration by PC.

NOTE: For further details of module configuration, refer to DSE Publication: 057-172 DSE45xx Configuration Software Manual.

3.11 ADDING AN EXTERNAL SOUNDER

Should an external alarm or indicator be required, this can be achieved by using the DSE Configuration Suite PC software to configure an auxiliary output for “Audible Alarm”, and by configuring an auxiliary input for “Alarm Mute” (if required).

The audible alarm output activates and de-activates at the same time as the module’s internal sounder. The Alarm mute input and internal alarm mute button activate ‘in parallel’ with each other. Either signal will mute both the internal sounder and audible alarm output.

Example of configuration to achieve external sounder with external alarm mute button:

The screenshot shows two configuration panels. The top panel, titled "Relay Outputs (DC Supply Out)", has a table with columns "Output E", "Source", and "Polarity". The "Source" dropdown is set to "Audible Alarm" and the "Polarity" dropdown is set to "Energise". The bottom panel, titled "Digital Input A", has a "Function" dropdown set to "Alarm Mute".

3.12 ACCUMULATED INSTRUMENTATION

NOTE: When an accumulated instrumentation value exceeds the maximum number as listed below, it will reset and begin counting from zero again.

Engine Hours Run	Maximum 99999 hrs 59 minutes (Approximately 11yrs 4months)
Accumulated Power (Not available on the DSE45xx-01 variant)	999999 kWh / kVAh / kVAh

The number of logged Engine Hours and Number of Starts can be set/reset using the DSE Configuration Suite PC software. Depending upon module configuration, this may have been PIN number locked by your generator supplier

3.13 DIMENSIONS AND MOUNTING

3.13.1 DIMENSIONS

140.0mm x 113mm x 43mm
(5.5" x 4.4" x 1.7")

3.13.2 PANEL CUTOUT

118mm x 92mm
(4.6" x 3.6")

3.13.3 WEIGHT

0.16kg
(0.35lb)

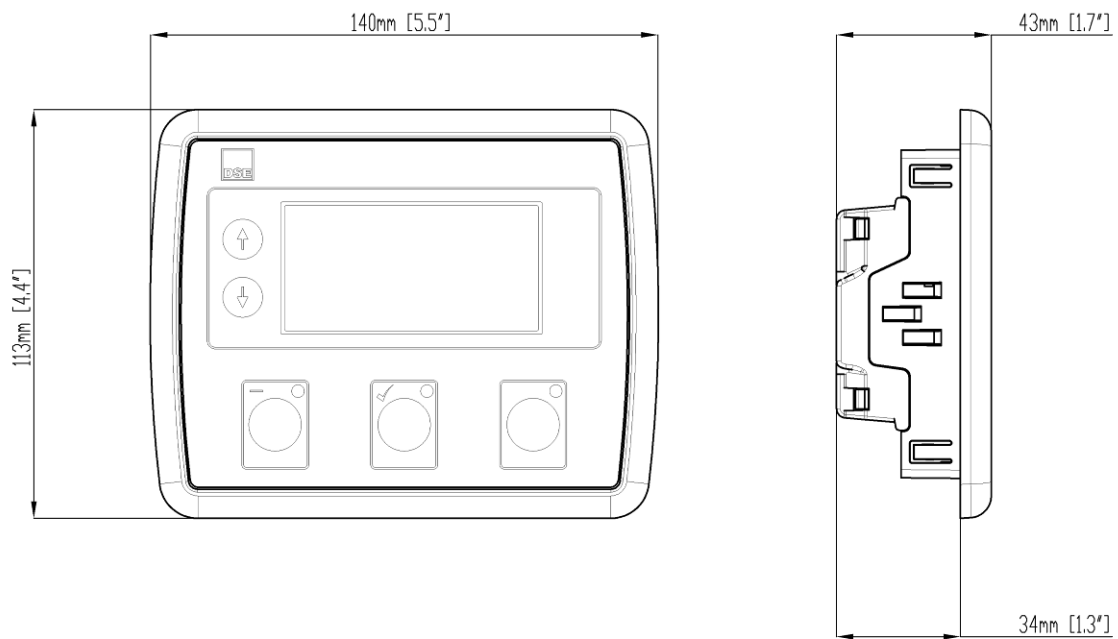

3.13.4 FIXING CLIPS

The module is held into the panel fascia using the supplied fixing clips.

- Withdraw the fixing clip screw (turn anticlockwise) until only the pointed end is protruding from the clip.
- Insert the three 'prongs' of the fixing clip into the slots in the side of the module case.
- Pull the fixing clip backwards (towards the back of the module) ensuring all three prongs of the clip are inside their allotted slots.
- Turn the fixing clip screws clockwise until they make contact with the panel fascia.
- Turn the screws a little more to secure the module into the panel fascia. Care should be taken not to over tighten the fixing clip screws.

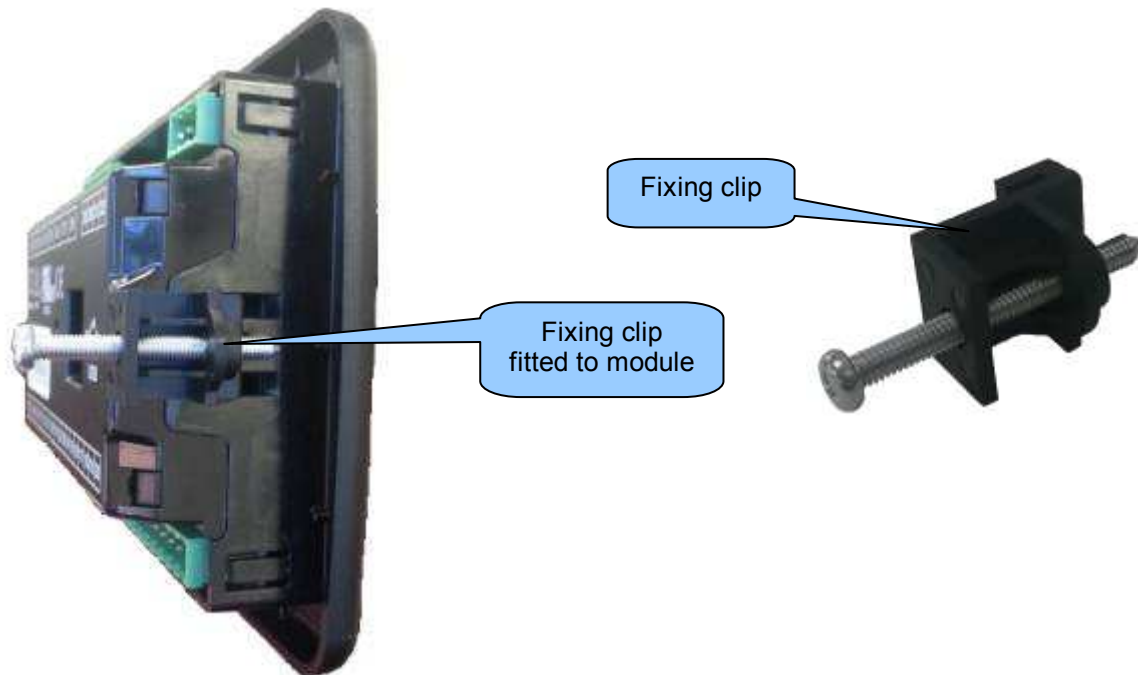

▲NOTE: In conditions of excessive vibration, mount the module on suitable anti-vibration mountings.

3.13.5 SILICON SEALING GASKET

NOTE: For purchasing an additional silicon gasket from DSE, please see the section entitled **Maintenance, Spares, Repair and Servicing** elsewhere in this document.

The optional silicon gasket provides improved sealing between module and the panel fascia. The gasket is fitted to the module before installation into the panel fascia. Take care to ensure the gasket is correctly fitted to the module to maintain the integrity of the seal.



Sealing gasket



Gasket fitted to module

3.13.6 APPLICABLE STANDARDS

BS 4884-1	This document conforms to BS4884-1 1992 Specification for presentation of essential information.
BS 4884-2	This document conforms to BS4884-2 1993 Guide to content
BS 4884-3	This document conforms to BS4884-3 1993 Guide to presentation
BS EN 60068-2-1 (Minimum temperature)	-30°C (-22°F)
BS EN 60068-2-2 (Maximum temperature)	+70°C (158°F)
BS EN 60950	Safety of information technology equipment, including electrical business equipment
BS EN 61000-6-2	EMC Generic Immunity Standard (Industrial)
BS EN 61000-6-4	EMC Generic Emission Standard (Industrial)
BS EN 60529 (Degrees of protection provided by enclosures)	IP65 (front of module when installed into the control panel with the optional sealing gasket) IP42 (front of module when installed into the control panel WITHOUT being sealed to the panel)
UL508 NEMA rating (Approximate)	12 (Front of module when installed into the control panel with the optional sealing gasket). 2 (Front of module when installed into the control panel WITHOUT being sealed to the panel)
IEEE C37.2 (Standard Electrical Power System Device Function Numbers and Contact Designations)	<p>Under the scope of IEEE 37.2, <i>function numbers can also be used to represent functions in microprocessor devices and software programs.</i> The controller is device number 11L-8000 (Multifunction device protecting Line (generator) –module).</p> <p>As the module is configurable by the generator OEM, the functions covered by the module will vary. Under the module's factory configuration, the device numbers included within the module are :</p> <ul style="list-style-type: none"> 2 – Time Delay Starting Or Closing Relay 3 – Checking Or Interlocking Relay 5 – Stopping Device 6 – Starting Circuit Breaker 8 – Control Power Disconnecting Device 10 – Unit Sequence Switch 11 – Multifunction Device 12 – Overspeed Device 14 – Underspeed Device 26 – Apparatus Thermal Device 27AC – AC Undervoltage Relay 27DC – DC Undervoltage Relay 29 – Isolating Contactor Or Switch 30 – Annunciator Relay 31 – Separate Excitation Device 42 – Running Circuit Breaker

Continued overleaf...

Specification

IEEE C37.2 (Standard Electrical Power System Device Function Numbers and Contact Designations)	Continued... 50 – Instantaneous Overcurrent Relay 52 – AC Circuit Breaker 53 – Exciter Or DC Generator Relay 54 – Turning Gear Engaging Device 59AC – AC Overvoltage Relay 59DC – DC Overvoltage Relay 62 – Time Delay Stopping Or Opening Relay 63 – Pressure Switch 71 – Level Switch 74 – Alarm Relay 81 – Frequency Relay 83 – Automatic Selective Control Or Transfer Relay 86 – Lockout Relay
---	--

In line with our policy of continual development, Deep Sea Electronics, reserve the right to change specification without notice.

3.13.7 ENCLOSURE CLASSIFICATIONS

3.13.7.1 IP CLASSIFICATIONS

The modules specification under BS EN 60529 Degrees of protection provided by enclosures

IP65 (Front of module when module is installed into the control panel with the optional sealing gasket).

IP42 (front of module when module is installed into the control panel WITHOUT being sealed to the panel)

First Digit	Second Digit
Protection against contact and ingress of solid objects	Protection against ingress of water
0 No protection	0 No protection
1 Protected against ingress solid objects with a diameter of more than 50 mm. No protection against deliberate access, e.g. with a hand, but large surfaces of the body are prevented from approach.	1 Protection against dripping water falling vertically. No harmful effect must be produced (vertically falling drops).
2 Protected against penetration by solid objects with a diameter of more than 12 mm. Fingers or similar objects prevented from approach.	2 Protection against dripping water falling vertically. There must be no harmful effect when the equipment (enclosure) is tilted at an angle up to 15° from its normal position (drops falling at an angle).
3 Protected against ingress of solid objects with a diameter of more than 2.5 mm. Tools, wires etc. with a thickness of more than 2.5 mm are prevented from approach.	3 Protection against water falling at any angle up to 60° from the vertical. There must be no harmful effect (spray water).
4 Protected against ingress of solid objects with a diameter of more than 1 mm. Tools, wires etc. with a thickness of more than 1 mm are prevented from approach.	4 Protection against water splashed against the equipment (enclosure) from any direction. There must be no harmful effect (splashing water).
5 Protected against harmful dust deposits. Ingress of dust is not totally prevented but the dust must not enter in sufficient quantity to interface with satisfactory operation of the equipment. Complete protection against contact.	5 Protection against water projected from a nozzle against the equipment (enclosure) from any direction. There must be no harmful effect (water jet).
6 Protection against ingress of dust (dust tight). Complete protection against contact.	6 Protection against heavy seas or powerful water jets. Water must not enter the equipment (enclosure) in harmful quantities (splashing over).

3.13.7.2 NEMA CLASSIFICATIONS

THE MODULES NEMA RATING (APPROXIMATE)

12 (Front of module when module is installed into the control panel with the optional sealing gasket).

2 (front of module when module is installed into the control panel WITHOUT being sealed to the panel)

▲ NOTE: There is no direct equivalence between IP / NEMA ratings. IP figures shown are approximate only.

1 IP30	Provides a degree of protection against contact with the enclosure equipment and against a limited amount of falling dirt.
2 IP31	Provides a degree of protection against limited amounts of falling water and dirt.
3 IP64	Provides a degree of protection against windblown dust, rain and sleet; undamaged by the formation of ice on the enclosure.
3R IP32	Provides a degree of protection against rain and sleet.; undamaged by the formation of ice on the enclosure.
4 (X) IP66	Provides a degree of protection against splashing water, windblown dust and rain, hose directed water; undamaged by the formation of ice on the enclosure. (Resist corrosion).
12/12K IP65	Provides a degree of protection against dust, falling dirt and dripping non corrosive liquids.
13 IP65	Provides a degree of protection against dust and spraying of water, oil and non corrosive coolants.

4 INSTALLATION

The module is designed to be mounted on the panel fascia. For dimension and mounting details, see the section entitled *Specification, Dimension and mounting* elsewhere in this document.

4.1 TERMINAL DESCRIPTION

To aid user connection, icons are used on the rear of the module to help identify terminal functions. An example of this is shown below.

NOTE: Availability of some terminals depends upon module version. Full details are given in the section entitled *Terminal Description* elsewhere in this manual.

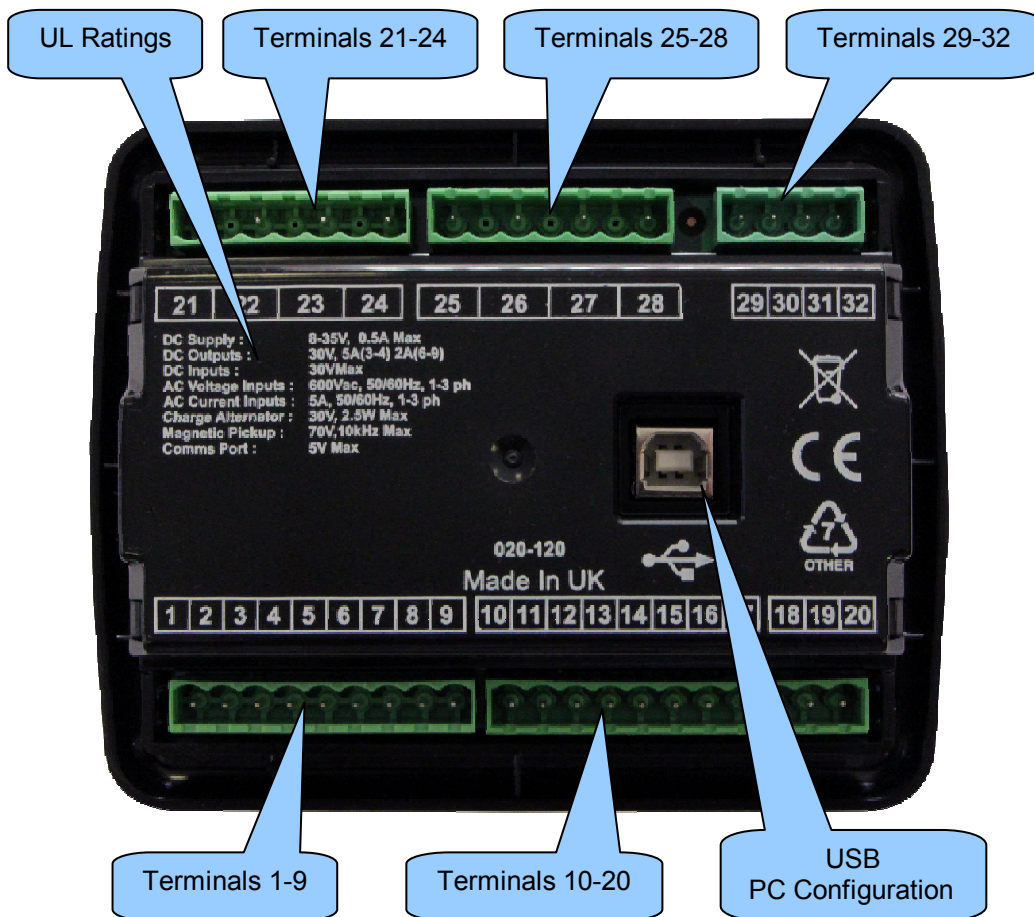

4.1.1 DC SUPPLY, FUEL AND START OUTPUTS, OUTPUTS C, D, E & F

Pin No	Description	Cable Size	Notes
1	DC Plant Supply Input (Negative)	2.5mm ² AWG 13	
2	DC Plant Supply Input (Positive)	2.5 mm ² AWG 13	Supplies the module and DC Outputs A, B, C, D, E & F
3	DC Output A (FUEL)	2.5mm ² AWG 13	Plant Supply Positive from terminal 2. 10A for 10secs, 5A resistive continuous Fixed as FUEL relay if electronic engine is not configured.
4	DC Output B (START)	2.5mm ² AWG 13	Plant Supply Positive from terminal 2. 10A for 10secs, 5A resistive continuous Fixed as START relay if electronic engine is not configured.
5	Charge Fail / Excite	2.5mm ² AWG 13	Do not connect to ground (battery negative). If charge alternator is not fitted, leave this terminal disconnected.
6	DC Output C	1.0mm ² AWG 18	Plant Supply Positive from terminal 2. 2 Amp rated.
7	DC Output D	1.0mm ² AWG 18	Plant Supply Positive from terminal 2. 2 Amp rated.
8	DC Output E	1.0mm ² AWG 18	Plant Supply Positive from terminal 2. 2 Amp rated.
9	DC Output F	1.0mm ² AWG 18	Plant Supply Positive from terminal 2. 2 Amp rated.

 **NOTE: Terminals 8 & 9 are not fitted to DSE4510 controller.**

 **NOTE: When the module is configured for operation with an electronic engine, FUEL and START output requirements may be different. For further details on connection to electronic engines, refer to DSE Publication: 057-004 *Electronic Engines And DSE Wiring***

 **NOTE: For further details of module configuration, refer to DSE Publication: 057-172 *DSE45xx Configuration Software Manual.***

4.1.2 ANALOGUE SENSOR

Pin No	Description	Cable Size	Notes
10	Sensor Common Return	0.5mm ² AWG 20	Return Feed For Sensors
11	Oil Pressure Input	0.5mm ² AWG 20	Connect To Oil Pressure Sensor
12	Coolant Temperature Input	0.5mm ² AWG 20	Connect To Coolant Temperature Sensor
13	Fuel Level Input	0.5mm ² AWG 20	Connect To Fuel Level Sensor

▲ NOTE: It is VERY important that terminal 10 (sensor common) is soundly connected to an earth point on the ENGINE BLOCK, not within the control panel, and must be a sound electrical connection to the sensor bodies. This connection MUST NOT be used to provide an earth connection for other terminals or devices. The simplest way to achieve this is to run a SEPARATE earth connection from the system earth star point, to terminal 10 directly, and not use this earth for other connections.

▲ NOTE: If you use PTFE insulating tape on the sensor thread when using earth return sensors, ensure you do not insulate the entire thread, as this will prevent the sensor body from being earthed via the engine block.

▲ NOTE: For further details of module configuration, refer to DSE Publication: 057-172 *DSE45xx Configuration Software Manual*.

4.1.3 CONFIGURABLE DIGITAL INPUTS & CAN

Pin No	Description	Cable Size	Notes
14	Configurable Digital Input A	0.5mm ² AWG 20	Switch to negative
15	Configurable Digital Input B	0.5mm ² AWG 20	Switch to negative
16	Configurable Digital Input C	0.5mm ² AWG 20	Switch to negative
17	Configurable Digital Input D	0.5mm ² AWG 20	Switch to negative
18	CAN Port H	0.5mm ² AWG 20	Use only 120Ω CAN approved cable
19	CAN Port L	0.5mm ² AWG 20	Use only 120Ω CAN approved cable
20	CAN Port Screen	Shield	Use only 120Ω CAN approved cable

NOTE: For further details of module configuration, refer to DSE Publication: *057-172 DSE45xx Configuration Software Manual*.

NOTE: For further details on connection to electronic engines, refer to DSE Publication: *057-004 Electronic Engines And DSE Wiring*

NOTE: Screened 120Ω impedance cable specified for use with CAN must be used for the CAN link.
DSE stock and supply Belden cable 9841 which is a high quality 120Ω impedance cable suitable for CAN use (DSE part number 016-030)

4.1.4 GENERATOR / MAINS VOLTAGE & FREQUENCY SENSING

Pin No	Description	Cable Size	Notes
21	Generator L1 (U) Voltage Monitoring	1.0mm ² AWG 18	Connect to generator L1 (U) output (AC) (Recommend 2A fuse)
22	Generator L2 (V) Voltage Monitoring	1.0mm ² AWG 18	Connect to generator L2 (V) output (AC) (Recommend 2A fuse)
23	Generator L3 (W) Voltage Monitoring	1.0mm ² AWG 18	Connect to generator L3 (W) output (AC) (Recommend 2A fuse)
24	Generator Neutral (N) Input	1.0mm ² AWG 18	Connect to generator Neutral terminal (AC)
25	Mains L1 (R) Voltage Monitoring	1.0mm ² AWG 18	Connect to Mains L1 (R) output (AC) (Recommend 2A fuse)
26	Mains L2 (S) Voltage Monitoring	1.0mm ² AWG 18	Connect to Mains L2 (S) output (AC) (Recommend 2A fuse)
27	Mains L3 (T) Voltage Monitoring	1.0mm ² AWG 18	Connect to Mains L3 (T) output (AC) (Recommend 2A fuse)
28	Mains Neutral (N) Input	1.0mm ² AWG 18	Connect to Mains Neutral terminal (AC)

NOTE: Terminals 25 to 28 not fitted to DSE4510

NOTE: The above table describes connections to a three phase, four wire alternator. For alternative wiring topologies, please see the Alternate Topology Wiring Diagrams section of this manual.

4.1.5 GENERATOR CURRENT TRANSFORMERS

NOTE: Current Sensing (terminals 29 to 32) is not fitted to the DSE45xx-01 variant.

WARNING! Do not disconnect this plug when the CTs are carrying current. Disconnection will open circuit the secondary of the C.T.'s and dangerous voltages may then develop. Always ensure the CTs are not carrying current and the CTs are short circuit connected before making or breaking connections to the module.

NOTE: The module has a burden of 0.5VA on the CT. Ensure the CT is rated for the burden of the controller, the cable length being used and any other equipment sharing the CT. If in doubt, consult your CT supplier.

Pin No	Description	Cable Size	Notes
29	CT Secondary for L1	2.5mm ² AWG 13	Connect to s1 secondary of L1 monitoring CT
30	CT Secondary for L2	2.5mm ² AWG 13	Connect to s1 secondary of L2 monitoring CT
31	CT Secondary for L3	2.5mm ² AWG 13	Connect to s1 secondary of L3 monitoring CT
32	CT Common	2.5mm ² AWG 13	

4.1.5.1 CT CONNECTIONS

p1, \hat{k} or K is the primary of the CT that 'points' towards the GENERATOR



p2, \hat{l} or L is the primary of the CT that 'points' towards the Load

s1 is the secondary of the CT that connects to the DSE Module's input for the CT measuring

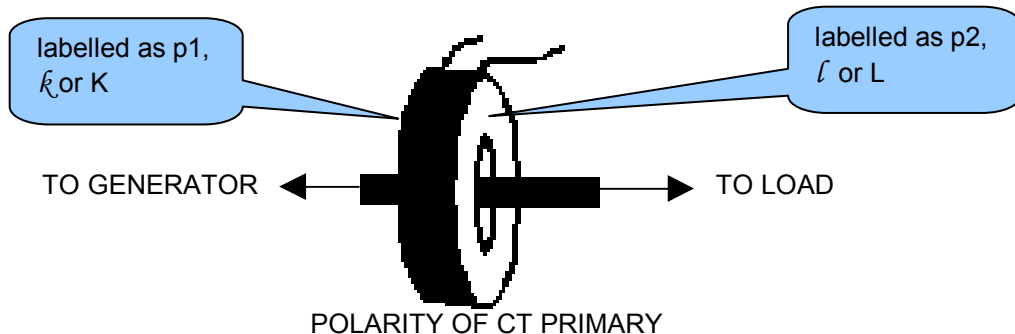
s2 is the secondary of the CT that should be commoned with the s2 connections of all the other CTs and connected to the CT common terminal of the module.



4.1.6 PC CONFIGURATION INTERFACE CONNECTOR

	Description	Cable Size	Notes
	Socket for connection to PC with DSE Configuration Suite Software	0.5mm ² AWG 20	This is a standard USB type A to type B connector. 

▲ NOTE: The USB connection cable between the PC and the module must not be extended beyond 5m (yards). For distances over 5m, it is possible to use a third party USB extender. Typically, they extend USB up to 50m (yards). The supply and support of this type of equipment is outside the scope of Deep Sea Electronics PLC.

▲ CAUTION!: Care must be taken not to overload the PC's USB system by connecting more than the recommended number of USB devices to the PC. For further information, consult your PC supplier.

▲ NOTE: For further details of module configuration, refer to DSE Publication: *057-172 DSE45xx Configuration Software Manual*.

4.2 TYPICAL WIRING DIAGRAM

As every system has different requirements, these diagrams show only a TYPICAL system and do not intend to show a complete system.

Genset manufacturers and panel builders may use these diagrams as a starting point; however, you are referred to the completed system diagram provided by your system manufacturer for complete wiring detail.

Further wiring suggestions are available in the following DSE publications, available at www.deepseapl.com to website members.

DSE Part	Description
056-022	Breaker Control (Training guide)
057-004	Electronic Engines and DSE Wiring

4.2.1 DSE4510 TYPICAL WIRING DIAGRAM (3 PHASE 4 WIRE)

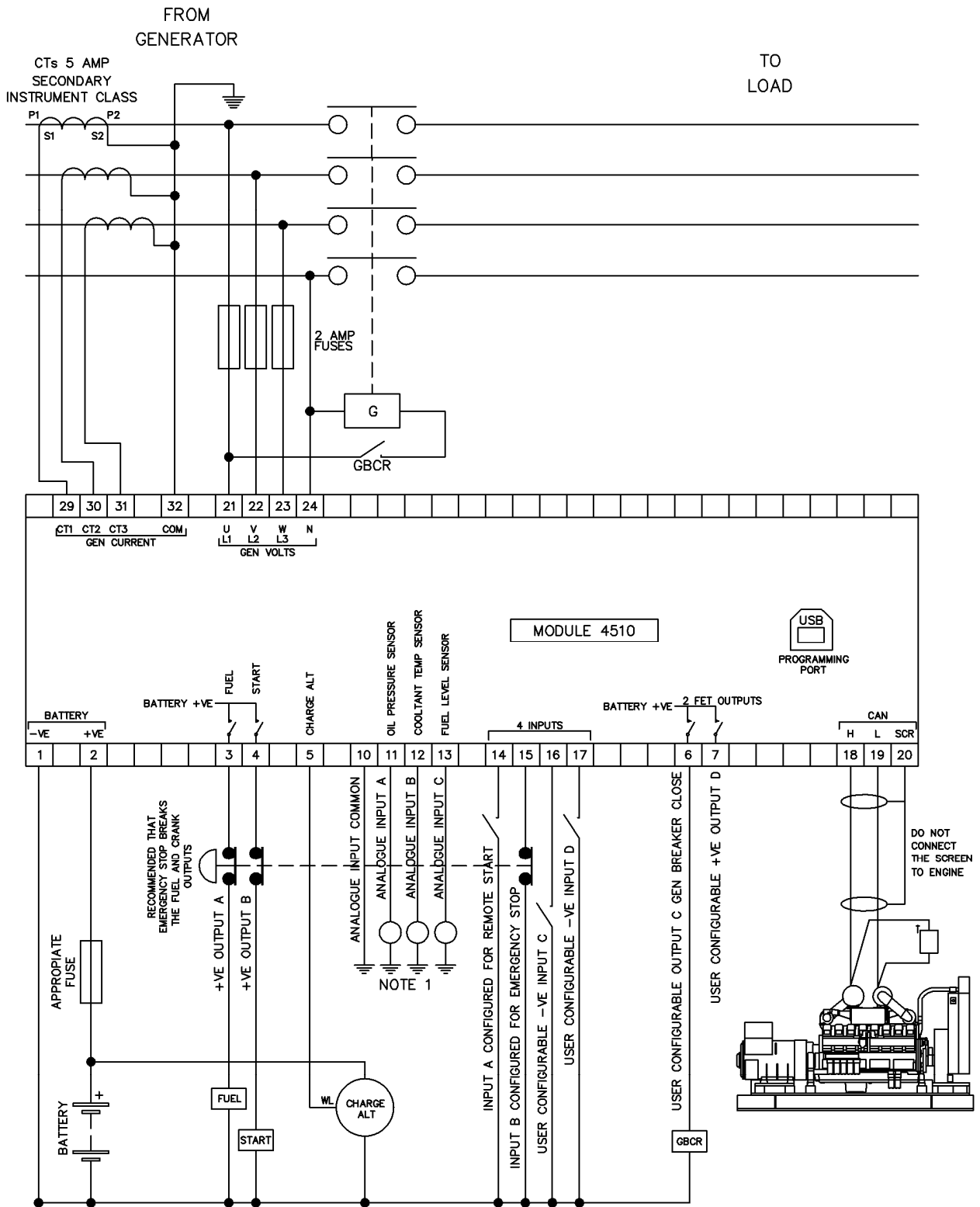

BATTERY NEGATIVE MUST BE GROUNDED
 NOTE 1. THESE GROUND CONNECTIONS MUST BE ON THE ENGINE BLOCK, AND MUST BE TO THE SENSOR BODIES.
 † NOTE 2. 120 R TERMINATING RESISTOR MAY BE REQUIRED EXTERNALLY, SEE ENGINE MANUFACTURERS LITERATURE.

NOTE: Terminals 29-32 are not fitted on the DSE45xx-01 variant.

4.2.2 DSE4520 TYPICAL WIRING DIAGRAM (3 PHASE 4 WIRE)

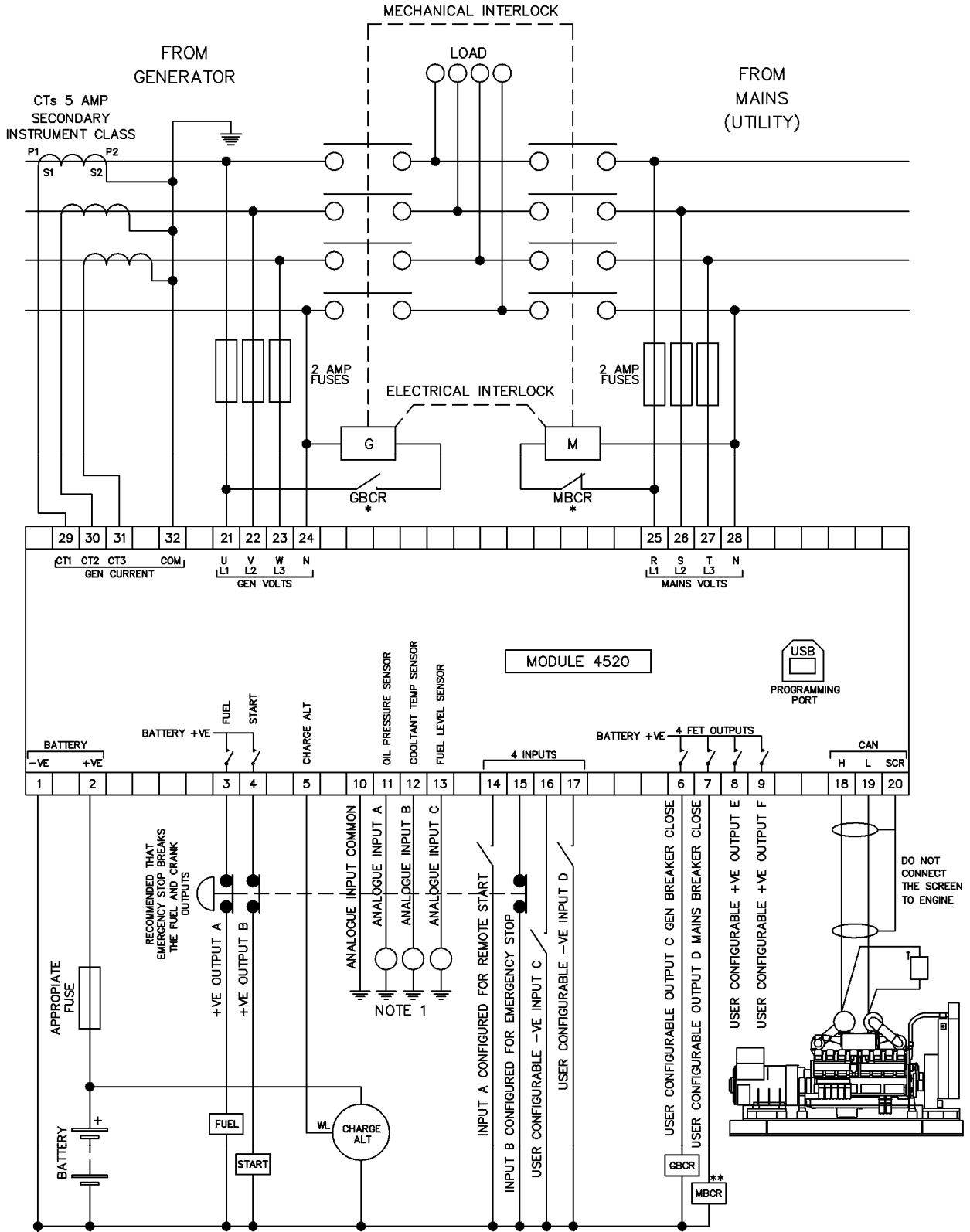

BATTERY NEGATIVE MUST BE GROUNDING

NOTE 1. THESE GROUND CONNECTIONS MUST BE ON THE ENGINE BLOCK, AND MUST BE TO THE SENSOR BODIES.

*NOTE 3. IT IS RECOMMENDED THAT THE GENERATOR AND MAINS SWITCHING DEVICES ARE MECHANICALLY AND ELECTRICALLY INTERLOCKED.

†NOTE 2. 120 R TERMINATING RESISTOR MAY BE REQUIRED EXTERNALLY, SEE ENGINE MANUFACTURERS LITERATURE.

**NOTE 4. MAINS BREAKER CLOSED OUTPUT SHOULD BE CONFIGURED FOR DE-ENERGISE CLOSE MAINS, AND USE THE NORMALLY CLOSED CONTACTS OF MBCR

NOTE: Terminals 29-32 are not fitted on the DSE45xx-01 variant.

4.3 ALTERNATE TOPOLOGY WIRING DIAGRAMS

4.3.1 GENERATOR

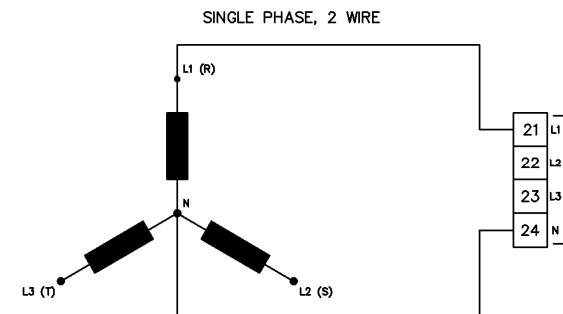
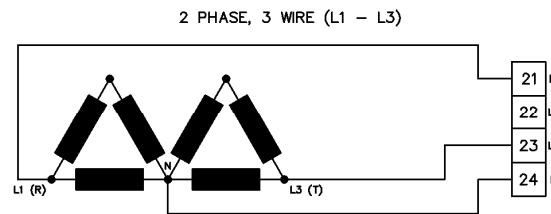
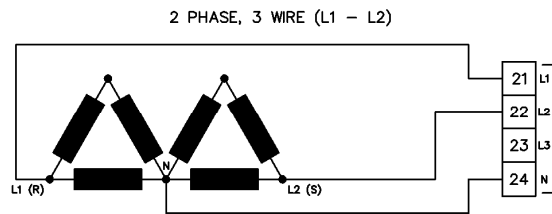
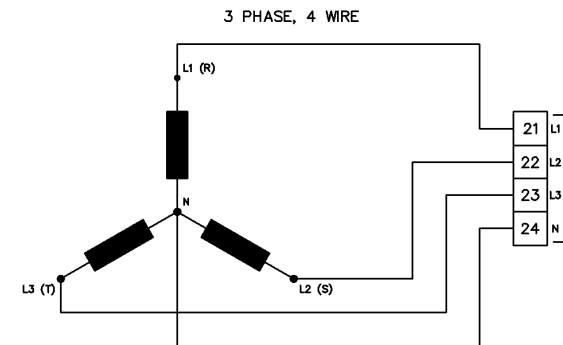
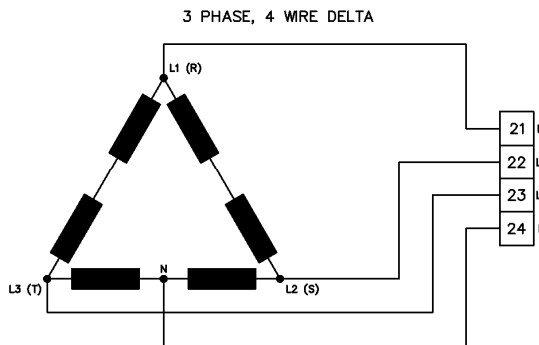
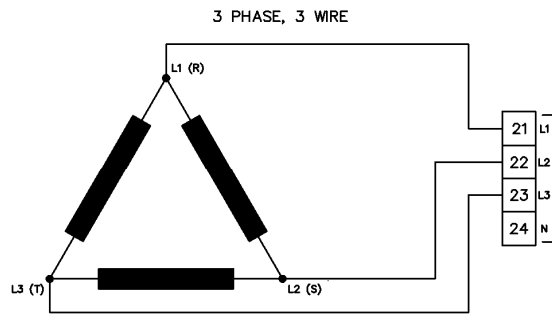

4.3.2 MAINS (4520 ONLY)

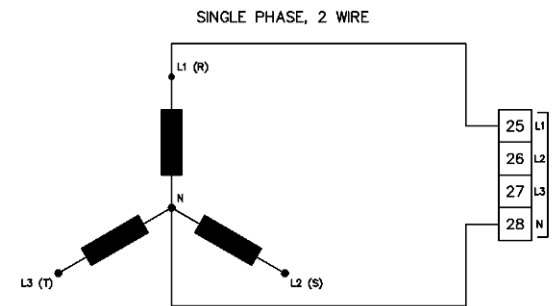
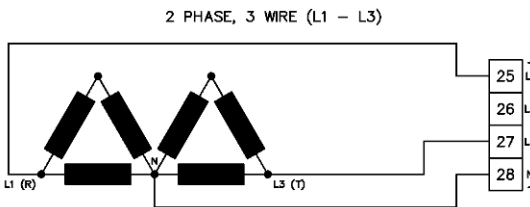
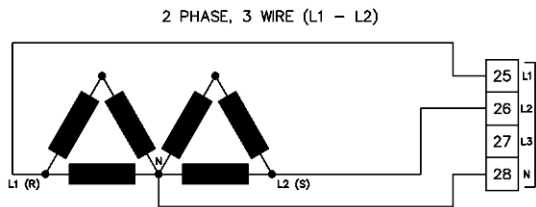
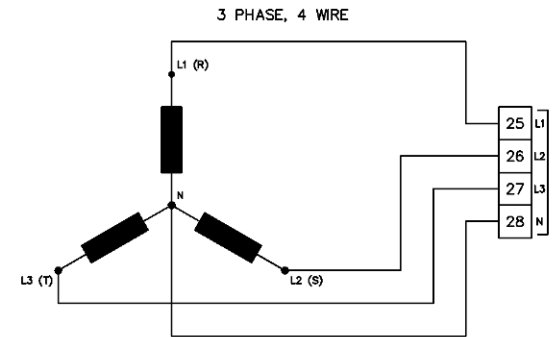
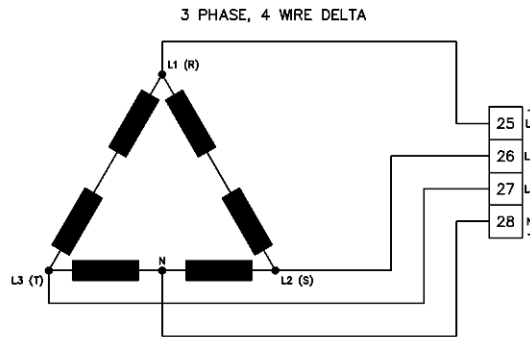
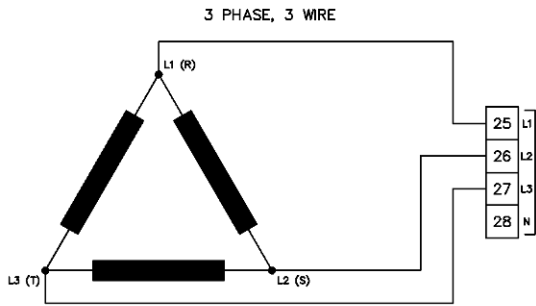

4.4 EARTH SYSTEMS

4.4.1 NEGATIVE EARTH

The typical wiring diagrams located within this document show connections for a negative earth system (the battery negative connects to Earth)

4.4.2 POSITIVE EARTH

When using a DSE module with a Positive Earth System (the battery positive connects to Earth), the following points must be followed:

- Follow the typical wiring diagram as normal for all sections EXCEPT the earth points
- All points shown as Earth on the typical wiring diagram should connect to BATTERY NEGATIVE (not earth).

4.4.3 FLOATING EARTH



Where neither the battery positive nor battery negative terminals are connected to earth the following points must to be followed

- Follow the typical wiring diagram as normal for all sections EXCEPT the earth points
- All points shown as Earth on the typical wiring diagram should connect to BATTERY NEGATIVE (not earth).

5 DESCRIPTION OF CONTROLS

NOTE: The following descriptions detail the sequences followed by a module containing the standard 'factory configuration'. Always refer to your configuration source for the exact sequences and timers observed by any particular module in the field.





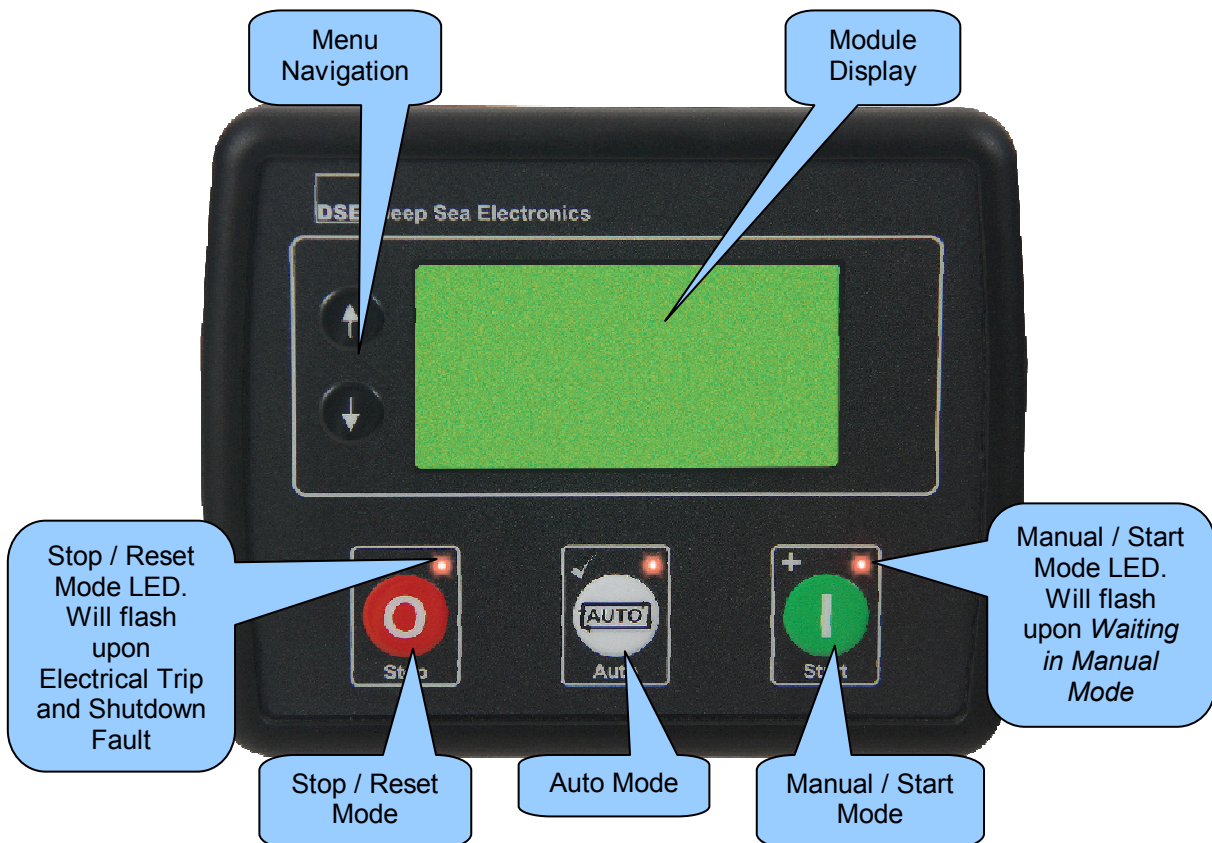



Control of the module is via push buttons mounted on the front of the module with

Stop/Reset Mode , **Auto Mode**  and **Manual/Start Mode**  functions. For normal operation, these are the only controls which need to be operated. Details of their operation are provided later in this document.



CAUTION: The module may instruct an engine start event due to external influences. Therefore, it is possible for the engine to start at any time without warning. Prior to performing any maintenance on the system, it is recommended that steps are taken to remove the battery and isolate supplies.

5.1 CONTROL PUSH-BUTTONS

Icon	Description
	<p>Stop / Reset Mode</p> <p>This button places the module into its Stop/Reset Mode . This will clear any alarm conditions for which the triggering criteria have been removed. If the engine is running and the module is put into Stop mode, the module will automatically instruct the generator to unload ('Close Generator' and 'Delayed Load Output 1, 2, 3 & 4' become inactive (if used)). The fuel supply de-energises and the engine comes to a standstill. Should any form of remote start signal be present while operating in this mode, a start will <u>not</u> occur.</p>
	<p>Auto Mode</p> <p>This button places the module into its Auto Mode . This mode allows the module to control the function of the generator automatically. The module will monitor the <i>remote start</i> input and battery charge status and once a start request is made, the set will be automatically started and placed on load ('Close Generator' and 'Delayed Load Output 1, 2, 3 & 4' become active in order from lowest to highest (if used)).</p> <p>Upon removal of the starting signal, the module will remove the load from the generator and shut the set down observing the <i>stop delay</i> timer and <i>cooling</i> timer as necessary ('Close Generator' and 'Delayed Load Output 1, 2, 3 & 4' become inactive at once (if used)). The module will then await the next start event. <i>For further details, please see the more detailed description of 'Auto operation' elsewhere in this manual.</i></p>
	<p>Manual / Start Mode</p> <p>This button will start the engine and run off load. To place the generator on load, digital inputs are required to be assigned to perform this function.</p> <p>If the engine is running off-load in Manual/Start Mode  button and a remote start signal becomes present, the module will automatically instruct the changeover device to place the generator on load ('Close Generator' and 'Delayed Load Output 1, 2, 3 & 4' becomes active (if used)). Upon removal of the <i>Remote Start Signal</i>, the generator remains on load until either selection of the Stop/Reset Mode  or Auto Mode .</p>
	<p>Menu Navigation</p> <p>Used for navigating the instrumentation, event log and configuration screens. For further details, please see the more detailed description of these items elsewhere in this manual.</p>

5.2 MODULE DISPLAY

The module's display contains the following sections. Description of each section can be viewed in the sub sections.

NOTE: Depending upon the module's configuration, some display screens may be disabled. For further details of module configuration, refer to DSE Publication: 057-172 *DSE45xx Configuration Software Manual*.

<i>Inst. Icon</i>	Instrumentation	Unit	<i>Alarm Icon</i>
<i>Active Config</i>	Instrumentation	Unit	
<i>FPE / Auto Run</i>	Instrumentation	Unit	<i>Mode Icon</i>
<i>Load Switching Icons</i>			

Example of DSE4510 Home Page Display

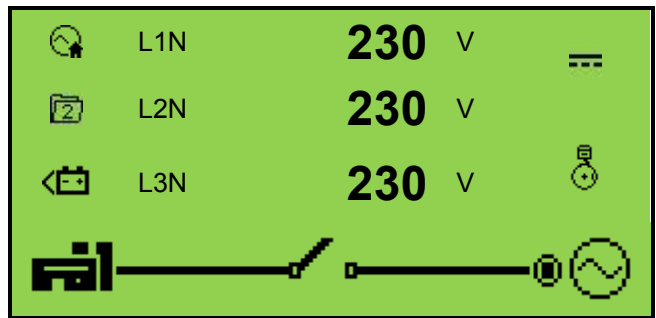



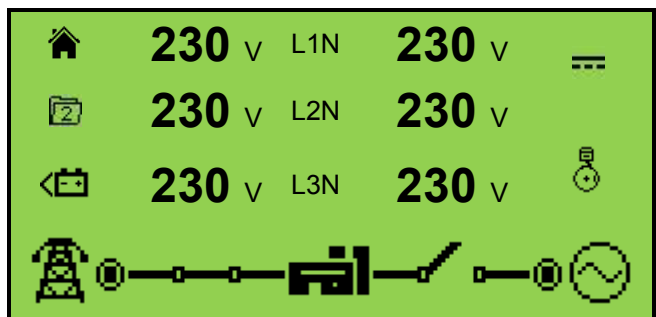















Example of DSE4520 Home Page Display





5.2.1 INSTRUMENTATION ICONS

When viewing instrumentation pages, an icon is displayed in the **Inst. Icon** section to indicate what section is currently being displayed.

Icon	Details
	The default home page which displays generator voltage and mains voltage (DSE4520 only)
	Generator voltage and frequency instrumentation screen
	Mains voltage and frequency instrumentation screen (DSE4520 only)
	Generator current instrumentation screen
	Mains current instrumentation screen (DSE4520 only when CT in load location)
	Load power instrumentation screen
	Engine speed instrumentation screen
	Hours run instrumentation screen
	Battery voltage instrumentation screen
	Oil pressure instrumentation screen
	Coolant temperature instrumentation screen
	Flexible sender instrumentation screen
	Appears when the event log is being displayed
	Current time held in the unit
	The current value of the scheduler run time and duration
	ECU diagnostic trouble codes
	Oil Filter maintenance timers
	Air Filter maintenance timers
	Fuel Filter maintenance timers

5.2.2 ACTIVE CONFIGURATION





An icon is displayed in the **Active Config** section to indicate the active configuration within the currently selected within the controller.

Icon	Details
	Appears when the main configuration is selected.
	Appears when the alternative configuration is selected.

5.2.3 FRONT PANEL EDITOR (FPE) / AUTO RUN ICON









NOTE: For further details about the Front Panel Editor, see the section entitled 'Front Panel Editor' elsewhere in this manual.

When running in Auto Mode and on the Home (/ ) page, an icon is displayed in the **FPE / Auto Run** section to indicate the source of the auto start signal.

Icon	Auto Run Reason
	Appears when a remote start input is active
	Appears when a low battery run is active
	Mains failure
	Appears when a scheduled run is active





5.2.4 MODE ICON

An icon is displayed in the **Mode Icon** section to indicate the mode the controller is currently in.

Icon	Details
	Appears when the engine is at rest and the unit is in stop mode.
	Appears when the engine is at rest and the unit is in auto mode.
	Appears when the engine is at rest and the unit is waiting for a manual start.
	Appears when a timer is active, for example cranking time, crank rest etc.
	Appears when the engine is running, and all timers have expired, either on or off load. The animation speed is reduced when running in idle mode.
	Appears when the unit is in the front panel editor.
	Appears when a USB connection is made to the controller.
	Appears if either the configuration file or engine file becomes corrupted.

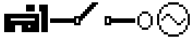
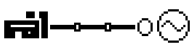
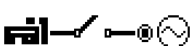
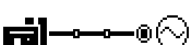
5.2.5 LOAD SWITCHING ICON

An icon is displayed in the **Load Switching Icon** section to indicate the current operation status of the controller.

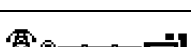
Icon	Details
	Appears when the generator is at rest or not available and when the generator breaker is open.
	Appears when the generator is at rest or not available and the generator breaker has failed to open.
	Appears when the generator is available and the generator breaker is open.
	Appears when the generator is available and the generator breaker is closed.
	Appears when the mains supply is not available and the mains breaker is open. (DSE4520 Only)
	Appears when the mains supply is not available and the mains breaker is closed. (DSE4520 Only)
	Appears when the mains supply is available and the mains breaker is open. (DSE4520 Only)
	Appears when the mains supply is available and the mains breaker is closed. (DSE4520 Only)

5.2.6 BACKLIGHT

The LCD backlight is on if the unit has sufficient voltage while the unit is turned on, unless the unit is cranking for which the backlight is turned off.

5.2.7 ALARM ICONS (PROTECTIONS)

An icon is displayed in the **Alarm Icon** section to indicate the alarm that is current active on the controller.

In the event of a warning alarm, the LCD only displays the **Alarm Icon**. In the event of an electrical trip or shutdown alarm, the module displays the **Alarm Icon** and the **Stop/Reset Mode**  button LED begins to flash.

If multiple alarms are active at the same time, the **Alarm Icon** automatically cycles through all the appropriate icons to indicate each alarm which is active.

Example:



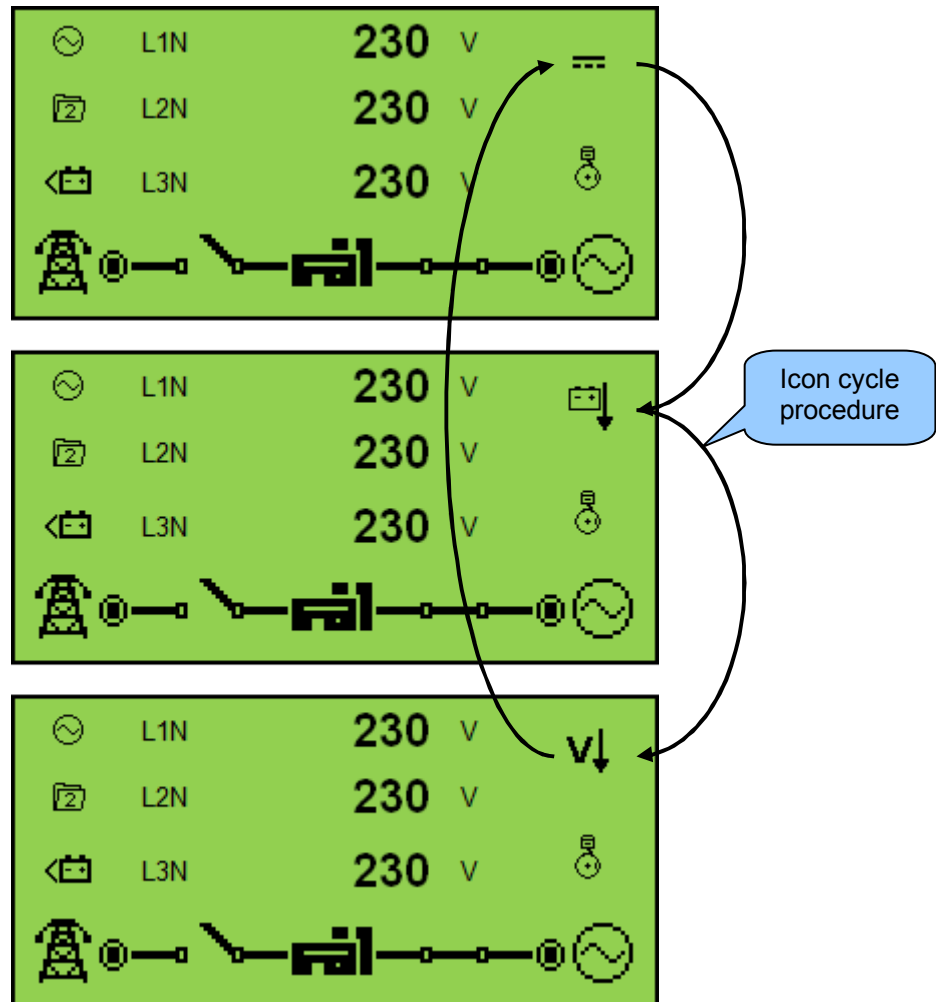















If the DSE controller was sensing a charge alternator failure alarm, delay over current alarm and a AC under voltage alarm at the same time, it would cycle through all of the icons to show this.



5.2.7.1 WARNING ALARM ICONS

Warnings are non-critical alarm conditions and do not affect the operation of the generator system, they serve to draw the operators attention to an undesirable condition.

By default, warning alarms are self-resetting when the fault condition is removed. However enabling 'all warnings are latched' will cause warning alarms to latch until reset manually. This is enabled using the DSE Configuration Suite in conjunction with a compatible PC.







Icon	Fault	Description
	Auxiliary Inputs	The module detects that an auxiliary input which has been user configured to create a fault condition has become active.
	Analogue Input Configured As Digital	The analogue inputs can be configured to digital inputs. The module detects that an input configured to create a fault condition has become active.
	Fail To Stop	The module has detected a condition that indicates that the engine is running when it has been instructed to stop. NOTE: 'Fail to Stop' could indicate a faulty oil pressure sensor. If engine is at rest check oil sensor wiring and configuration.
	Charge Failure	The auxiliary charge alternator voltage is low as measured from the W/L terminal.
	Low Fuel Level	The level detected by the fuel level sensor is below the low fuel level pre-set pre-alarm setting.
	High Fuel Level	The level detected by the fuel level sensor is above the high fuel level pre-set pre-alarm setting.
	Battery Under Voltage	The DC supply has fallen below or risen above the low volts pre-set pre-alarm setting.
	Battery Over Voltage	The DC supply has risen above the high volts pre-set pre-alarm setting.
	Generator Under Voltage	The generator output voltage has fallen below the pre-set pre-alarm setting after the Safety On timer has expired.
	Generator Over Voltage	The generator output voltage has risen above the pre-set pre-alarm setting.
	Generator Under Frequency	The generator output frequency has fallen below the pre-set pre-alarm setting after the Safety On timer has expired.
	Generator Over Frequency	The generator output frequency has risen above the pre-set pre-alarm setting.
	CAN ECU Fault	The engine ECU has detected an alarm
	CAN Data Fail	The module is configured for CAN operation and does not detect data on the engine Can data link.
	Immediate Over Current	The measured current has risen above the configured trip level.
	Delayed Over Current	The measured current has risen above the configured trip level for a configured duration.
	Oil Filter Maintenance Alarm	Maintenance due for oil filter.
	Air Filter Maintenance Alarm	Maintenance due for air filter
	Fuel Filter Maintenance Alarm	Maintenance due for fuel filter.

5.2.7.2 ELECTRICAL TRIP ALARM ICONS

Electrical trips are latching and stop the Generator but in a controlled manner. On initiation of the electrical trip condition the module de-energises all the ‘**Delayed Load Output**’ and the ‘**Close Gen Output**’ outputs to remove the load from the generator. Once this has occurred the module starts the Cooling timer and allows the engine to cool off-load before shutting down the engine. The alarm must be accepted and cleared, and the fault removed to reset the module.

Electrical trips are latching alarms and to remove the fault, press the *Stop/Reset Mode*  button on the module.

 **NOTE: The alarm condition must be rectified before a reset will take place. If the alarm condition remains, it is not possible to reset the unit (The exception to this is the Low Oil Pressure alarm and similar ‘active from safety on’ alarms, as the oil pressure is low with the engine at rest).**













Icon	Fault	Description
	Auxiliary Inputs	The module detects that an auxiliary input which has been user configured to create a fault condition has become active.
	Analogue Input Configured As Digital	The analogue inputs can be configured to digital inputs. The module detects that an input configured to create a fault condition has become active.
	Low Fuel Level	The level detected by the fuel level sensor is below the low fuel level pre-set alarm setting.
	High Fuel Level	The level detected by the fuel level sensor is above the high fuel level pre-set alarm setting.
	Delayed Over Current	The measured current has risen above the configured trip level for a configured duration.
	kW Overload	The measured kW has risen above the configured trip level for a configured duration.

5.2.7.3 SHUTDOWN ALARM ICONS













Shutdown alarms are latching and immediately stop the Generator. On initiation of the shutdown condition the module de-energises all the ‘**Delayed Load Output**’ and the ‘**Close Gen Output**’ outputs to remove the load from the generator. Once this has occurred, the module shuts the generator set down immediately to prevent further damage. The alarm must be accepted and cleared, and the fault removed to reset the module.

Shutdowns are latching alarms and to remove the fault, press the *Stop/Reset Mode*  button on the module.

 **NOTE: The alarm condition must be rectified before a reset will take place. If the alarm condition remains, it is not possible to reset the unit (The exception to this is the Low Oil Pressure alarm and similar ‘active from safety on’ alarms, as the oil pressure is low with the engine at rest).**

Icon	Fault	Description
	Auxiliary Inputs	The module detects that an auxiliary input which has been user configured to create a fault condition has become active.
	Analogue Input Configured As Digital	The analogue inputs can be configured to digital inputs. The module detects that an input configured to create a fault condition has become active.
	Fail To Start	The engine has failed to start after the configured number of start attempts
	Low Oil Pressure	The module detects that the engine oil pressure has fallen below the low oil pressure pre-alarm setting level after the Safety On timer has expired.
	Engine High Temperature	The module detects that the engine coolant temperature has exceeded the high engine temperature pre-alarm setting level after the Safety On timer has expired.
	Under Speed	The engine speed has fallen below the under speed pre alarm setting
	Over Speed	The engine speed has risen above the over speed pre alarm setting
	Charge Failure	The auxiliary charge alternator voltage is low as measured from the W/L terminal.
	Low Fuel Level	The level detected by the fuel level sensor is below the low fuel level pre-set alarm setting.
	High Fuel Level	The level detected by the fuel level sensor is above the high fuel level pre-set alarm setting.
	Generator Under Voltage	The generator output voltage has fallen below the pre-set alarm setting. after the Safety On timer has expired.
	Generator Over Voltage	The generator output voltage has risen above the pre-set alarm setting.

Additional shutdown alarm icons can be viewed overleaf.



Icon	Fault	Description
	Generator Under Frequency	The generator output frequency has fallen below the pre-set alarm setting after the Safety On timer has expired.
	Generator Over Frequency	The generator output frequency has risen above the pre-set alarm setting.
	Delayed Over Current	The measured current has risen above the configured trip level for a configured duration.
	kW Overload	The measured kW has risen above the configured trip level for a configured duration.
	CAN ECU Fault	The engine ECU has detected an alarm – CHECK ENGINE LIGHT Contact Engine Manufacturer for support.
	CAN Data Fail	The module is configured for CAN operation and does not detect data on the engine Can data link.
	Emergency Stop	The emergency stop button has been depressed. This failsafe (normally closed to emergency stop) input and immediately stops the set should the signal be removed.
	Oil Sender Open Circuit	The oil pressure sensor has been detected as being open circuit.
	Coolant Temperature Sender Open Circuit	The coolant temperature sensor has been detected as being open circuit.
	Oil Filter Maintenance Alarm	Maintenance due for oil filter.
	Air Filter Maintenance Alarm	Maintenance due for air filter
	Fuel Filter Maintenance Alarm	Maintenance due for fuel filter.

5.3 VIEWING THE INSTRUMENT PAGES

5.3.1 NAVIGATION MENU

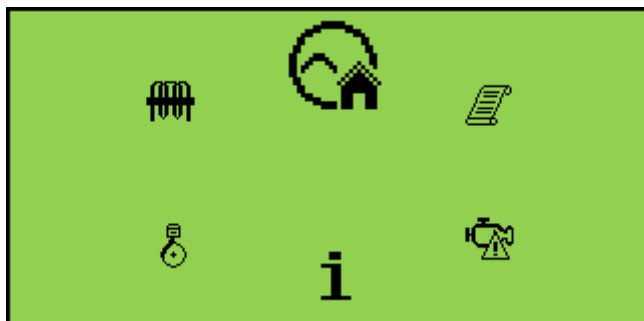

To enter the navigation menu, press both the  (up) and  (down) buttons simultaneously.



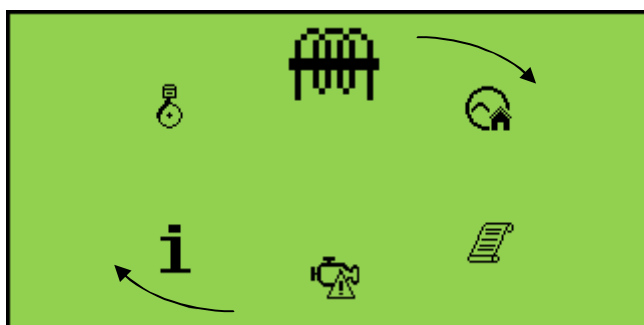







To select the required icon, press the  (up) button to cycle right or the  (down) button to cycle left until the desired instrumentation section is reached.





Once the desired icon is at the top, press the *Auto Mode*  (✓) button to enter that instrumentation section.

If the *Auto Mode*  (✓) button is not pressed, the display automatically returns to the Home  page after the configured setting of the *LCD Scroll Timer*.

5.3.1.1 NAVIGATION MENU ICONS

Icon	Description
	Generator and mains voltage instrumentation (DSE4520 only)
	Generator instrumentation
	Mains instrumentation (DSE4520 only)
	Current and load instrumentation (Not available in on the DSE45xx-01 variant)
	Engine instrumentation
	Module information
	Engine DTCs (Diagnostic Trouble Codes) if active
	Event Log

5.3.2 GENERAL NAVIGATION



It is possible to scroll through the display to view different pages of information by repeatedly operating the  (up) or  (down) navigation buttons.



If you want to view one of the instrument pages towards the end of the list, it may be quicker to scroll up through the pages rather than down!

Example:



And so on until the last page is reached.

A Further press of the navigation  (down) button returns the display to the Home (/ ) page.

Once selected, the page will remain on the LCD display until the user selects a different page or, after an extended period of inactivity (*Page Delay Timer*), the module reverts back to the Home (/ ) page.

The *Page Delay Timer* is configurable using the DSE Configuration Suite Software or by using the Front Panel Editor.

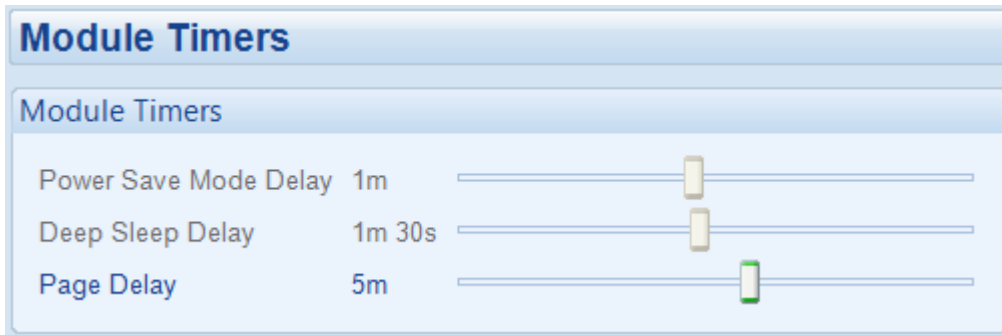

NOTE: For further details of module configuration, refer to DSE Publication: *057-172 DSE45xx Configuration Software Manual*.

5.3.3 HOME

This is the page that is displayed when no other page has been selected and is automatically displayed after a period of inactivity (*Page Delay Timer*) of the module facia buttons. It also contains the voltage reading of the generator and mains that is measured from the module's voltage inputs.

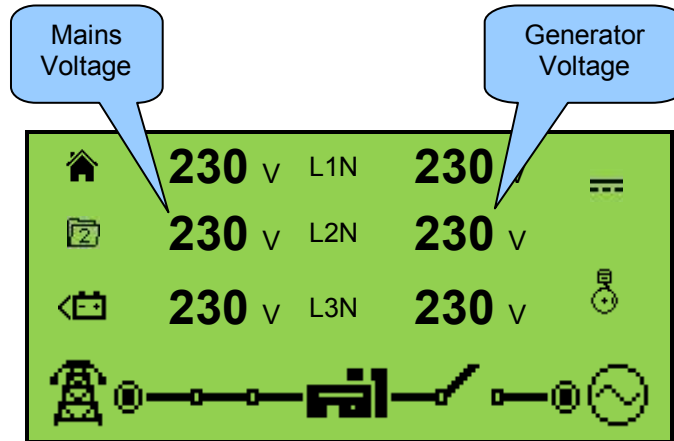

- Generator Voltage (ph-N / ph-ph)
- Mains Voltage (ph-N / ph-ph) (DSE4520 only)

5.3.4 GENERATOR

These pages contain electrical values of the generator, measured or derived from the module's voltage inputs.

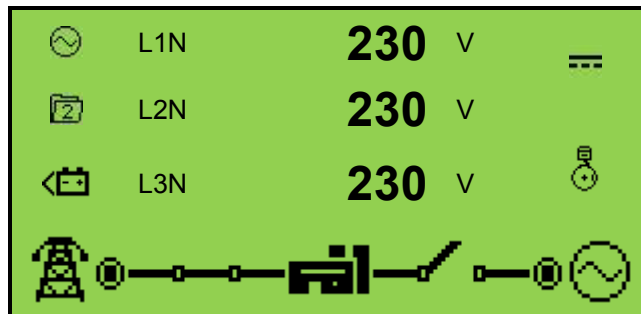

- Generator Voltage (ph-N)
- Generator Voltage (ph-ph)
- Generator Frequency

5.3.5 MAINS (DSE4520 ONLY)

These pages contain electrical values of the mains, measured or derived from the module's voltage inputs.

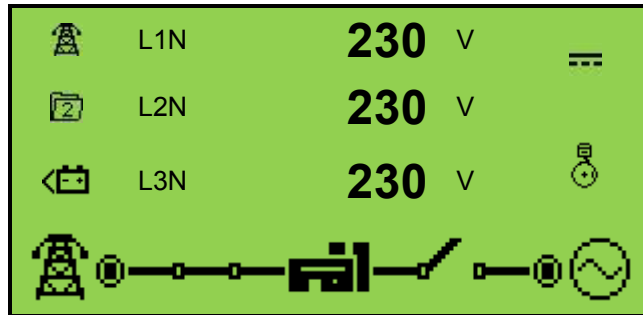

- Mains Voltage (ph-N)
- Mains Voltage (ph-ph)
- Mains Frequency

5.3.6 LOAD

These pages contain electrical values of the load, measured or derived from the module's voltage and current inputs. The power values displayed depend on which supply is on load.

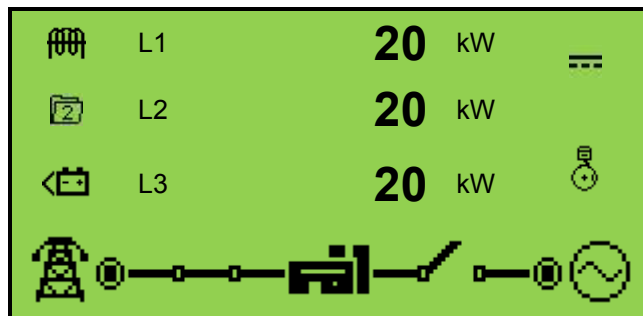

- Generator Current (A) *
- Mains Current (A) (DSE4520 only)*
- Load ph-N (kW) *
- Total Load (kW) *
- Load ph-N (kVA) *
- Total Load (kVA) *
- Load ph-N (kVAr) *
- Total Load (kVAr) *
- Power Factor ph-N *
- Power Factor Average *
- Accumulated Load (kWh, kVAh, kVArh) *

 **NOTE: * Not applicable to the DSE45xx-01 variant.**

5.3.7 ENGINE

These pages contain instrumentation gathered about the engine measured or derived from the module's inputs, some of which may be obtained from the engine ECU.

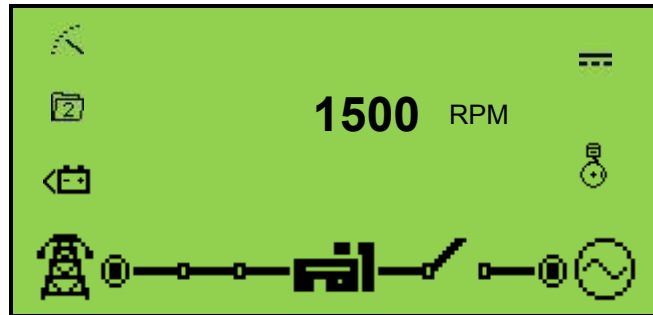

- Engine Speed
- Engine Run Time
- Engine Battery Volts
- Engine Coolant Temperature
- Engine Oil Pressure
- Engine Fuel Level / Flexible Sensor
- Engine Maintenance Due – Oil
- Engine Maintenance Due – Air
- Engine Maintenance Due – Fuel

5.3.8 INFO

These pages contain information about the controller.

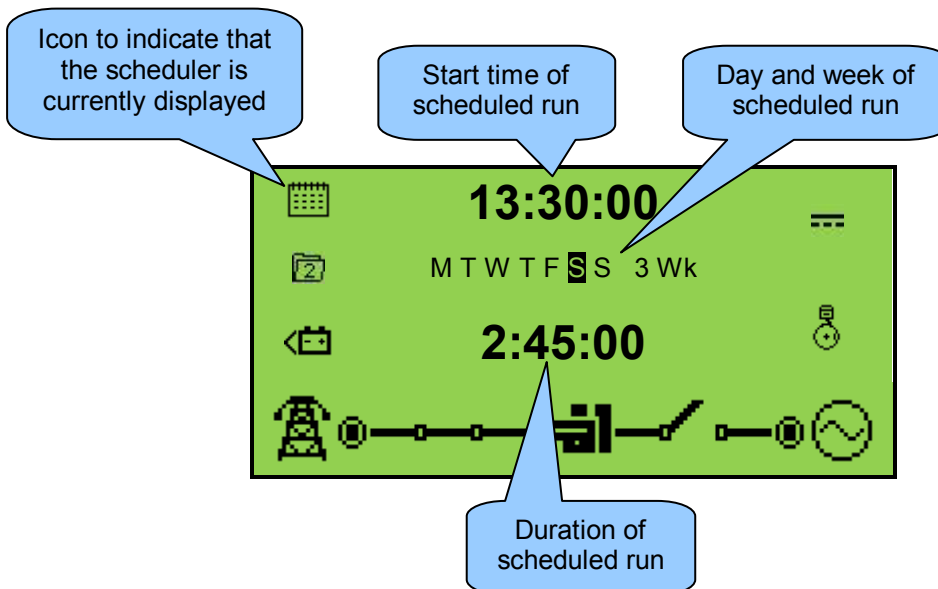





- Module's date and time
- Scheduler settings
- Product description and USB identification number
- Application and Engine Version

5.3.9 ENGINE DTC (ECU ALARMS)

If the DSE module is connected to an ECU, This page contains active *Diagnostic Trouble Codes (DTC)* only if the engine ECU generating a fault code. These are alarm conditions are detected by the engine ECU and displayed by the DSE controller.

5.3.9.1 VIEWING ACTIVE ENGINE DTC

To view the engine DTC(s), press both  (up) and  (down) buttons simultaneously, the navigation menu is then displayed. Once entered, cycle to the DTC () section and enter.





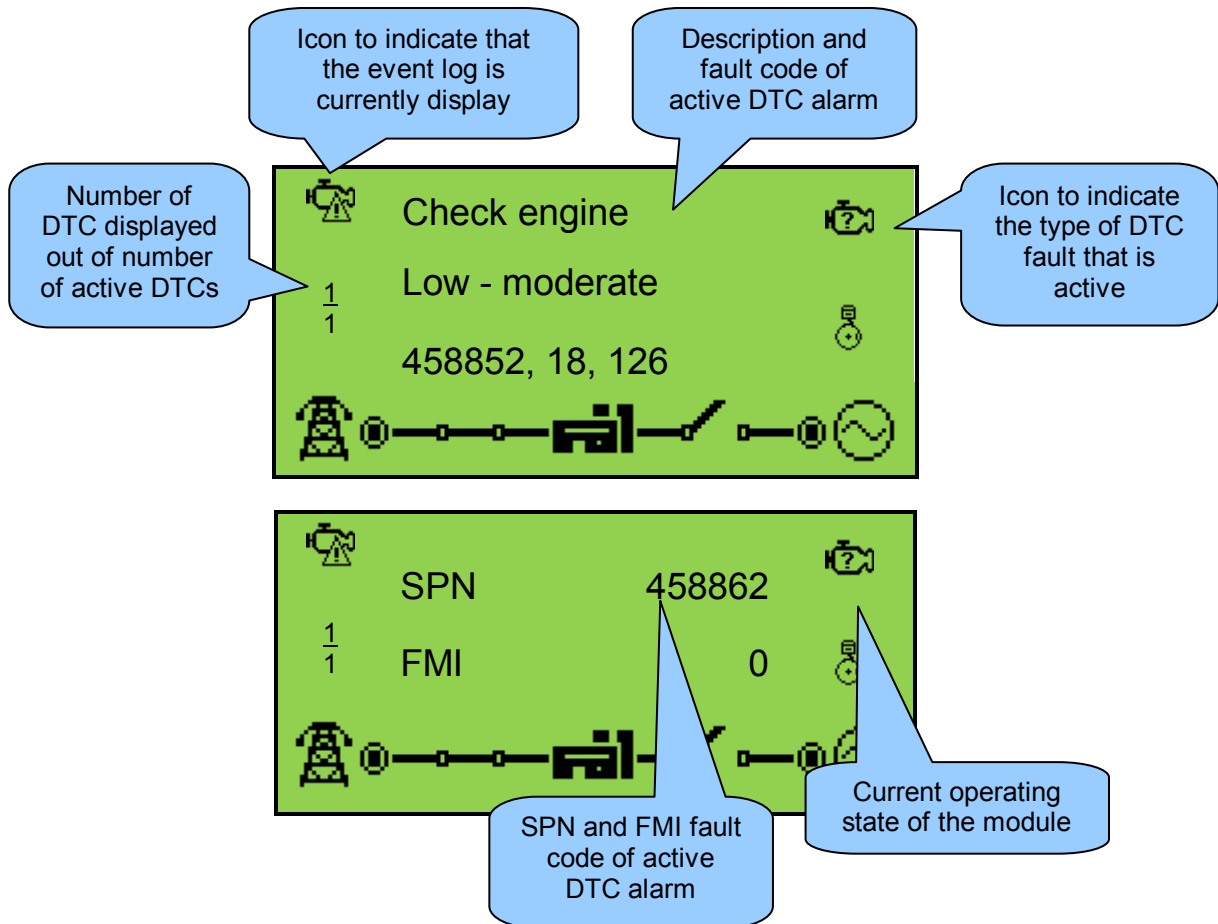

To view the active DTC(s) alarms, repeatedly press the  (up) or  (down) buttons until the LCD screen displays the alarm.

Continuing to press the  (up) or  (down) buttons will cycle through the alarms.

To exit the active DTC(s) alarm section, press the  (up) and  (down) buttons simultaneously to enter the navigation menu. Once entered, cycle to the desired instrumentation section.



A list of CAN fault icons is overleaf...

Icon	Fault	DTC Description
	Check Engine Fault	The engine ECU has detected a fault not recognised by the DSE module, contact engine manufacturer for support.
	Low Oil Pressure	The engine ECU has detected that the engine oil pressure has fallen below its configured low oil pressure alarm level.
	Under Speed	The engine ECU has detected that the engine speed has fallen below its configured under speed alarm level.
	Over Speed	The engine ECU has detected that the engine speed has risen above its configured over speed alarm level.
	Charge Failure	The engine ECU has detected that the engine's charge alternator output has fallen below its configured alarm level.
	Low Fuel Level	The engine ECU has detected that the engine's fuel level has fallen below its configured low fuel level alarm.
	Battery Under/Over Voltage	The engine ECU has detected that the engine's DC supply has fallen below or risen above its configured alarm level.

 **NOTE:** For details on these code meanings, refer to the ECU instructions provided by the engine manufacturer, or contact the engine manufacturer for further assistance.



 **NOTE:** For further details on connection to electronic engines, refer to DSE Publication: *057-004 Electronic Engines And DSE Wiring*



5.3.10 EVENT LOG



This module's event log contains a list of the last 15 record electrical trip or shutdown events and the engine hours at which they occurred.

Once the log is full, any subsequent electrical trip or shutdown alarms overwrites the oldest entry in the log. Hence, the log always contains the most recent shutdown alarms. The module logs the alarm, along with the engine running hours.

5.3.10.1 VIEWING THE EVENT LOG

To view the event log, press both  (up) and  (down) buttons simultaneously, the navigation menu is then displayed. Once entered, cycle to the event log () section and enter.

To view the event log, repeatedly press the  (up) or  (down) buttons until the LCD screen displays the desired event.

Continuing to press down the  (up) or  (down) buttons will cycle through the past alarms after which the display shows the most recent alarm and the cycle begins again.

To exit the event log, press the  (up) and  (down) buttons simultaneously to enter the navigation menu. Once entered, cycle to the desired instrumentation section.

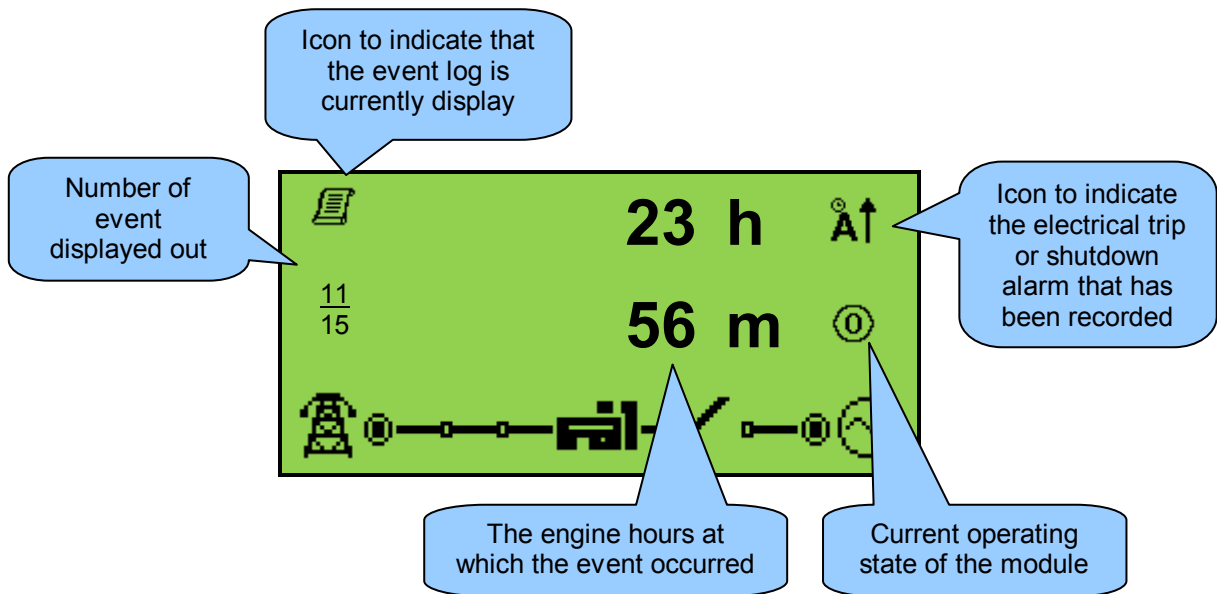

6 OPERATION

NOTE: The following descriptions detail the sequences followed by a module containing the standard 'factory configuration'. Always refer to your configuration source for the exact sequences and timers observed by any particular module in the field.

6.1 QUICKSTART GUIDE

This section provides a quick start guide to the module's operation.

6.1.1 STARTING THE ENGINE

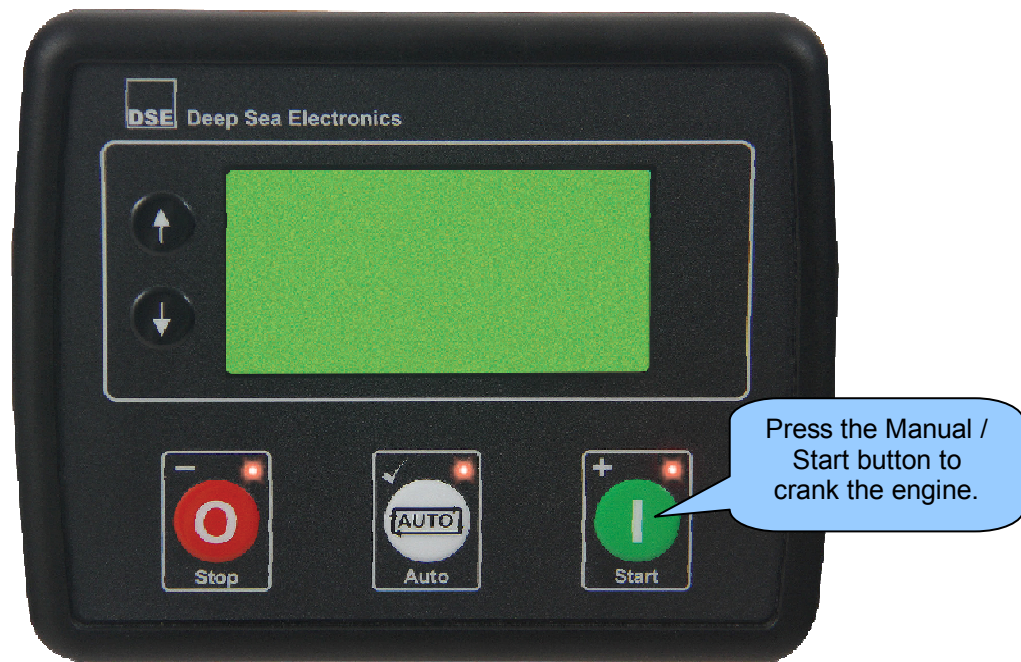

NOTE: For further details, see the section entitled 'OPERATION' elsewhere in this manual.

6.1.2 STOPPING THE ENGINE





▲ NOTE: For further details, see the section entitled 'OPERATION' elsewhere in this manual.

6.2 STOP/RESET MODE

NOTE: If a digital input configured to *panel lock* is active, changing module modes will not be possible. Viewing the instruments and event logs is NOT affected by panel lock.

Stop/Reset Mode is activated by pressing the *Stop/Reset Mode*  button.

The *Stop/Reset*  icon is displayed to indicate *Stop/Reset Mode* operations.

In *Stop/Reset Mode* , the module removes the generator from load (if necessary) before stopping the engine if it is already running.

If the engine does not stop when requested, the FAIL TO STOP alarm is activated (subject to the setting of the *Fail to Stop* timer). To detect the engine at rest the following must occur :

- Engine speed is zero as detected by the CANbus ECU
- Generator AC Voltage and Frequency must be zero.
- Engine Charge Alternator Voltage must be zero.
- Oil pressure sensor must indicate low oil pressure

When the engine has stopped, it is possible to send configuration files to the module from DSE Configuration Suite PC software and to enter the Front Panel Editor to change parameters.

Any latched alarms that have been cleared are reset when *Stop/Reset Mode*  is entered.

The engine is not started when in *Stop/Reset Mode* . If remote start signals are given, the input is ignored until *Auto Mode*  is entered.

When left in *Stop/Reset Mode*  with no presses of the fascia buttons and configured for 'Power Save Mode', the module enters Power Save Mode. To 'wake' the module, press any fascia control buttons or activate Digital Input A. The same is true for Deep Sleep Mode.

Power Save & Deep Sleep Modes in the DSE Configuration Suite Software

Power Save Mode Enable	<input checked="" type="checkbox"/>
Deep Sleep Mode Enable	<input checked="" type="checkbox"/>

NOTE: For further details of module configuration, refer to DSE Publication: *057-172 DSE45xx Configuration Software Manual*.

6.3 AUTOMATIC MODE

 **NOTE:** If a digital input configured to external *panel lock* is active, changing module modes is not possible. Viewing the instruments and event logs is NOT affected by panel lock.

Auto Mode is activated by pressing the *Auto Mode*  button.

The *Auto Mode*  icon is displayed to indicate *Auto Mode* operations if no alarms are present.

Auto mode allows the generator to operate fully automatically, starting and stopping as required with no user intervention.

6.3.1 WAITING IN AUTO MODE

If a starting request is made, the starting sequence begins. Starting requests can be from the following sources :

- Activation of an auxiliary input that has been configured to *remote start*
- Activation of the inbuilt exercise scheduler.

6.3.2 STARTING SEQUENCE

To allow for 'false' start requests, the *start delay* timer begins.

Should all start requests be removed during the *start delay* timer, the unit returns to a stand-by state.

If a start request is still present at the end of the *start delay* timer, the fuel relay is energised and the engine is cranked.

 **NOTE:** If the unit has been configured for CAN, compatible ECU's receive the start command via CAN and transmit the engine speed to the DSE controller.

If the engine fails to fire during this cranking attempt then the starter motor is disengaged for the *crank rest* duration after which the next start attempt is made. Should this sequence continue beyond the set number of attempts, the start sequence is terminated and the display shows  **Fail to Start.**

6.3.3 ENGINE RUNNING

Once the engine is running and all starting timers have expired, the animated *Engine Running*  icon is displayed.

The generator is placed on load if configured to do so.

 **NOTE:** The load transfer signal remains inactive until the Oil Pressure has risen. This prevents excessive wear on the engine.

If all start requests are removed, the *stopping sequence* will begin.

6.3.4 STOPPING SEQUENCE

The *return delay* timer operates to ensure that the starting request has been permanently removed and isn't just a short term removal. Should another start request be made during the cooling down period, the set returns on load.

If there are no starting requests at the end of the *return delay* timer, the load is removed from the generator to the mains supply and the *cooling* timer is initiated.

The *cooling* timer allows the set to run off load and cool sufficiently before being stopped. This is particularly important where turbo chargers are fitted to the engine.



After the *cooling* timer has expired, the set is stopped.

6.4 MANUAL/START MODE

NOTE: If a digital input configured to panel lock is active, changing module modes is not possible. Viewing the instruments and event logs is NOT affected by panel lock.

6.4.1 WAITING IN MANUAL MODE

To begin the starting sequence, press the *Manual/Start Mode*  button. If 'protected start' is disabled, the start sequence begins immediately.

If 'Protected Start' is enabled, the *Waiting in Manual Mode*  icon is displayed and the LED above the *Manual/Start Mode*  button flashes to indicate *Waiting in Manual Mode*.

The *Manual/Start Mode*  button must be pressed once more to begin the start sequence.

Protected Start Mode



Protected Start Mode setting in the DSE Configuration Suite Software

NOTE: For further details of module configuration, refer to DSE Publication: 057-172 *DSE45xx Configuration Software Manual*.

6.4.2 STARTING SEQUENCE

NOTE: There is no *start delay* in this mode of operation.

The fuel relay is energised and the engine is cranked.

NOTE: If the unit has been configured for CAN, compatible ECU's receives the start command via CAN.

If the engine fails to fire during this cranking attempt then the starter motor is disengaged for the *crank rest* duration after which the next start attempt is made. Should this sequence continue beyond the set number of attempts, the start sequence is terminated and the display shows **Fail to Start**.

When the engine fires the starter motor is disengaged. Speed detection is factory configured to be derived from the main alternator output frequency.

Additionally, rising oil pressure can be used disconnect the starter motor (but cannot detect under speed or over speed).

After the starter motor has disengaged, the *Safety On* timer activates, allowing Oil Pressure, High Engine Temperature, Under-speed, Charge Fail and any delayed Auxiliary fault inputs to stabilise without triggering the fault.

6.4.3 ENGINE RUNNING



Once the engine is running and all starting timers have expired, the animated *Engine Running*  icon is displayed.

In manual mode, the load is not transferred to the generator unless a 'loading request' is made. A loading request can come from a number of sources.

- Activation of an auxiliary input that has been configured to *Remote Start On Load or Auxiliary Mains Fail*.
- Activation of the inbuilt exercise scheduler if configured for 'on load' runs.



 NOTE: The load transfer signal remains inactive until the Oil Pressure has risen. This prevents excessive wear on the engine.

Once the generator has been placed on load, it is not automatically removed. To manually remove the load either:

- Press the *Auto Mode*  button to return to automatic mode. The set observes all auto mode start requests and stopping timers before beginning the *Auto Mode Stopping Sequence*.
- Press the *Stop/Reset Mode*  button to remove load and stop the generator.
- Activation of an auxiliary input that has been configured to *Generator Load Inhibit*.

6.4.4 STOPPING SEQUENCE

In manual/start mode the set will continue to run until either :

- The *Stop/Reset Mode*  button is pressed – The delayed load outputs are de-activated immediately and the set immediately stops.
- The *Auto Mode*  button is pressed. The set observes all auto mode start requests and stopping timers before beginning the *Auto Mode Stopping Sequence*.

6.5 MAINTENANCE ALARM

Depending upon module configuration one or more levels of engine maintenance alarm may occur based upon a configurable schedule.

Example 1

Screen capture from DSE Configuration Suite Software showing the configuration of the Maintenance Alarm for Oil, Air and Fuel.

When activated, the maintenance alarm can be either a **warning** (set continues to run) or **shutdown** (running the set is not possible).

Resetting the maintenance alarm is normally actioned by the site service engineer after performing the required maintenance.

The method of reset is either by:

- Activating an input that has been configured to Maintenance Reset Alarm x, where x is the type of maintenance alarm (Air, Fuel or Oil).
- Pressing the maintenance reset button in the DSE Configuration Suite, Maintenance section.
- Pressing and holding the *Stop/Reset Mode*  button for 10 seconds on the desired Maintenance Alarm status page. This can be protected by a PIN number.

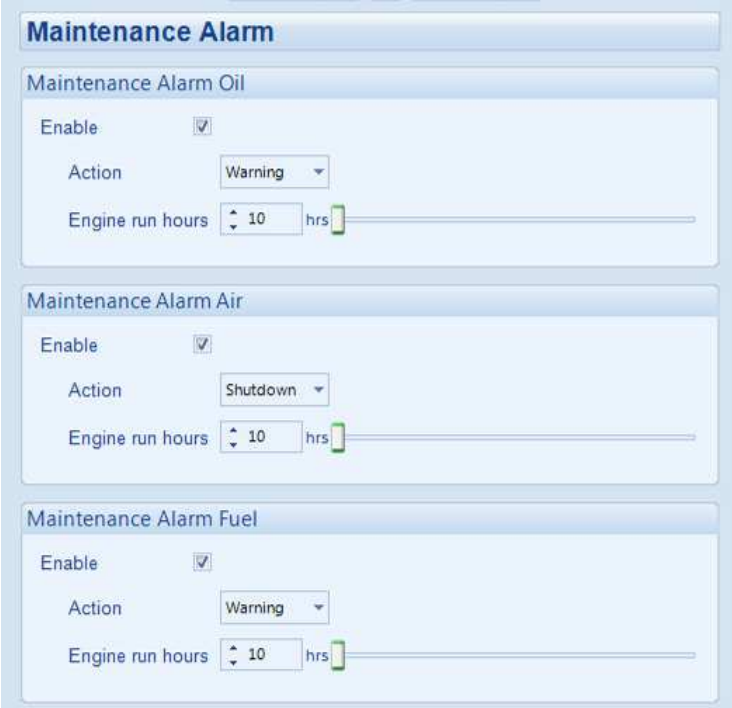

The screenshot shows three configuration panels for maintenance alarms:

- Maintenance Alarm Oil:** Enabled (checked), Action: Warning, Engine run hours: 10 hrs.
- Maintenance Alarm Air:** Enabled (checked), Action: Shutdown, Engine run hours: 10 hrs.
- Maintenance Alarm Fuel:** Enabled (checked), Action: Warning, Engine run hours: 10 hrs.

Example 2

Screen capture from DSE Configuration Suite Software showing the configuration of a digital input for Maintenance Reset Alarm Air.



The screenshot shows the configuration for Digital Input A:

- Function: Maintenance Reset Alarm Air
- Polarity: Close to Activate
- Action: (dropdown menu)
- Arming: (dropdown menu)
- Activation Delay: 0s

Example 3

Screen capture from DSE Configuration Suite Software showing the Maintenance Alarm Reset 'button' in the DSE Configuration Suite SCADA | MAINTENANCE section.

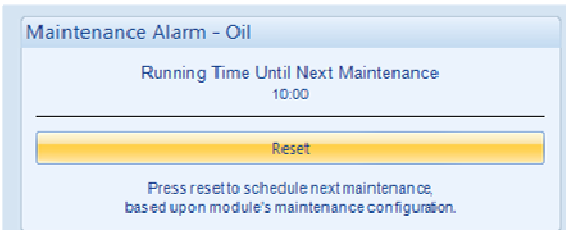

The screenshot shows the Maintenance Alarm - Oil status page:

- Running Time Until Next Maintenance: 10:00
- Reset button (yellow bar)
- Text: Press reset to schedule next maintenance, based upon module's maintenance configuration.

6.6 SCHEDULER

The controller contains an inbuilt exercise run scheduler, capable of automatically starting and stopping the set. Up to 8 scheduled start/stop sequences can be configured to repeat on a 7-day or 28-day cycle.

Scheduled runs may be on load or off load depending upon module configuration.

Example

Screen capture from DSE Configuration Suite Software showing the configuration of the Exercise Scheduler.

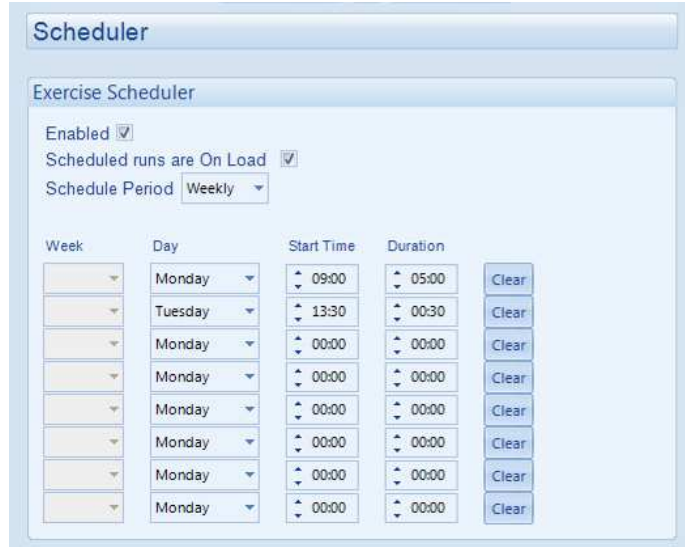

In this example the set will start at 09:00 on Monday and run for 5 hours, then start at 13:30 on Tuesday and run for 30 minutes.







6.6.1 STOP MODE

- Scheduled runs do not occur when the module is in *Stop/Reset Mode* .

6.6.2 MANUAL/START MODE

- Scheduled runs do not occur when the module is in *Manual/Start Mode*  waiting for a manual start.
- Activation of a Scheduled Run 'On Load' when the module is operating OFF LOAD in *Manual/Start Mode*  will force the set to run ON LOAD.

6.6.3 AUTO MODE

- Scheduled runs operate ONLY if the module is in *Auto Mode*  with no Shutdown or Electrical Trip alarm present.
- If the module is in *Stop/Reset Mode*  or *Manual/Start Mode*  when a scheduled run begins, the engine is not started. However, if the module is moved into *Auto Mode*  during a scheduled run, the engine will be called to start.
- Depending upon configuration by the system designer, an external input can be used to inhibit a scheduled run.
- If the engine is running OFF LOAD in *Auto Mode*  and a scheduled run configured to 'On Load' begins, the set is placed ON LOAD for the duration of the Schedule.







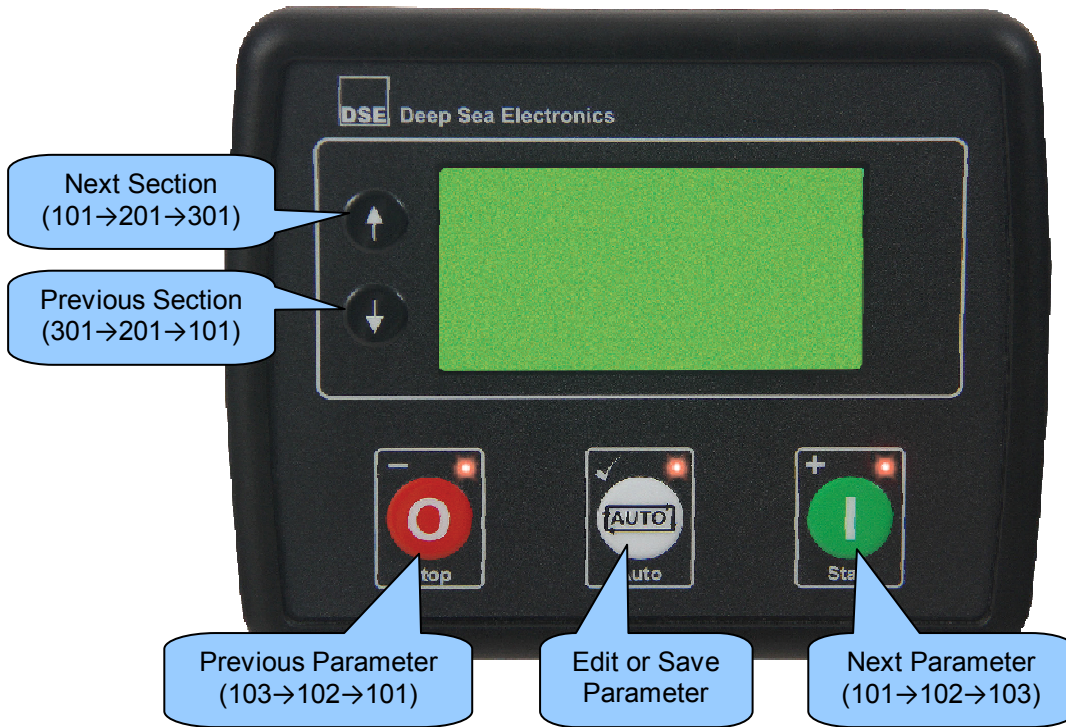





7 FRONT PANEL CONFIGURATION



This configuration mode allows the operator to fully configure the module through its display without the use of the DSE Configuration Suite PC Software.

Use the module's facia buttons to traverse the menu and make value changes to the parameters:



7.1 ACCESSING THE FRONT PANEL CONFIGURATION EDITOR

- Press the  (-) and  (✓) buttons together to enter the editor  mode.
- Press the  or  navigation buttons to cycle through the front panel editor to select the required page in the configuration tables.
- Press the  (+) to select the next parameter or  (-) to select the previous parameter within the current page.
- When viewing the parameter to be edited, press the  (✓) button, the value begins to flash.
- Press the  (+) or  (-) buttons to adjust the value to the required setting.
- Press the  (✓) button the save the current value, the value ceases flashing.
- Press and hold the  (✓) button to save and exit the editor, the configuration icon  is removed from the display.

 **NOTE:** Pressing and holding the  (+) or  (-) buttons will give auto-repeat functionality. Values can be changed quickly by holding the buttons for a prolonged period of time.

 **NOTE:** The editor automatically exits after 5 minutes of inactivity to ensure security.

 **NOTE:** The PIN number is not set by DSE when the module leaves the factory. If the module has a PIN code set, this has been affected by your generator supplier who should be contacted if you require the code. If the code has been 'lost' or 'forgotten', the module must be returned to the DSE factory to have the module's code removed. A charge will be made for this procedure.
NB - This procedure cannot be performed away from the DSE factory.

 **NOTE:** The PIN number is automatically reset when the editor is exited (manually or automatically) to ensure security.

 **NOTE:** More comprehensive module configuration is possible via PC configuration software. For further details of module configuration, refer to DSE Publication: 057-172 DSE45xx Configuration Software Manual.

7.2 ADJUSTABLE PARAMETERS

7.2.1 MODULE SETTINGS

x	Functionality in all DSE4510 & DSE4520 variants
x	Functionality in all DSE4520 variants
x	Functionality in DSE4510 & DSE4520 current sensing variants only
x	Functionality in DSE4510 & DSE4520 RT & RTH variants only

Configuration Parameters – Module (Page 1)		
101	Contrast	0 (%)
102	Fast Loading Enabled	On (1), Off (0)
103	All Warnings Latched	On (1), Off (0)
104	Lamp Test At Startup	On (1), Off (0)
105	Power Save Mode Enable	On (1), Off (0)
106	Deep Sleep Mode Enable	On (1), Off (0)
107	Protected Start Enable	On (1), Off (0)
108	Event Log Display Format	On (1), Off (0)
109	Power Up Mode	0 (Power Up Mode)
110	DTC String Enable	On (1), Off (0)
111	RESERVED	
112	Pin Protected Maintenance Reset	On (1), Off (0)
113	Stop Button Cooldown	On (1), Off (0)
114	Use Module Oil Pressure	On (1), Off (0)
115	Use Module Coolant Temp	On (1), Off (0)
116	Use Module Engine Hours	On (1), Off (0)
117	Use Module RPM	On (1), Off (0)
118	Use Module Charge Alt	On (1), Off (0)
119	Disable CAN Speed Control	On (1), Off (0)
120	CT Position	Gen (0), Load(1)
121	Generator Voltage Display	On (1), Off (0)
122	Mains Voltage Display	On (1), Off (0)
123	Generator Frequency Display	On (1), Off (0)
124	Mains Frequency Display	On (1), Off (0)
125	Current Display	On (1), Off (0)
126	kW Display	On (1), Off (0)
127	kVAr Display	On (1), Off (0)
128	kVA Display	On (1), Off (0)
129	pf Display	On (1), Off (0)
130	kWh Display	On (1), Off (0)
131	kVArh Display	On (1), Off (0)
132	kVAh Display	On (1), Off (0)

7.2.2 CAN SETTINGS

Configuration Parameters – Can Application (Page 2)		
201	CAN Alternative Engine Speed	On (1), Off (0)
202	CAN ECU Data Fail Enable	On (1), Off (0)
203	CAN ECU Data Fail Action	0 (Action)
204	CAN ECU Data Fail Delay	0 s

7.2.3 INPUT SETTINGS

Configuration Parameters – Inputs (Page 3)		
301	Digital Input A Source	0 (Input Source)
302	Digital Input A Polarity	0 (Polarity)
303	Digital Input A Action (If Source = User Config)	0 (Action)
304	Digital Input A Arming (If Source = User Config)	0 (Arming)
305	Digital Input A Activation Delay (If Source = User Config)	0 s
306	Digital Input B Source	0 (Input Source)
307	Digital Input B Polarity	0 (Polarity)
308	Digital Input B Action (If Source = User Config)	0 (Action)
309	Digital Input B Arming (If Source = User Config)	0 (Arming)
310	Digital Input B Activation Delay (If Source = User Config)	0 s
311	Digital Input C Source	0 (Input Source)
312	Digital Input C Polarity	0 (Polarity)
313	Digital Input C Action (If Source = User Config)	0 (Action)
314	Digital Input C Arming (If Source = User Config)	0 (Arming)
315	Digital Input C Activation Delay (If Source = User Config)	0 s
316	Digital Input D Source	0 (Input Source)
317	Digital Input D Polarity	0 (Polarity)
318	Digital Input D Action (If Source = User Config)	0 (Action)
319	Digital Input D Arming (If Source = User Config)	0 (Arming)
320	Digital Input D Activation Delay (If Source = User Config)	0 s
321-330	RESERVED	
331	Analogue Input A (Set As Digital) Source	0 (Input Source)
332	Analogue Input A (Set As Digital) Polarity	0 (Polarity)
333	Analogue Input A (Set As Digital) Action (If Source = User Config)	0 (Action)
334	Analogue Input A (Set As Digital) Arming (If Source = User Config)	0 (Arming)
335	Analogue Input A (Set As Digital) Activation Delay (If Source = User Config)	0 s
336	Analogue Input B (Set As Digital) Source	0 (Input Source)
337	Analogue Input B (Set As Digital) Polarity	0 (Polarity)
338	Analogue Input B (Set As Digital) Action (If Source = User Config)	0 (Action)
339	Analogue Input B (Set As Digital) Arming (If Source = User Config)	0 (Arming)
340	Analogue Input B (Set As Digital) Activation Delay (If Source = User Config)	0 s
341	Analogue Input C (Set As Digital) Source	0 (Input Source)
342	Analogue Input C (Set As Digital) Polarity	0 (Polarity)
343	Analogue Input C (Set As Digital) Action (If Source = User Config)	0 (Action)
344	Analogue Input C (Set As Digital) Arming (If Source = User Config)	0 (Arming)
345	Analogue Input C (Set As Digital) Activation Delay (If Source = User Config)	0 s

7.2.4 OUTPUT SETTINGS

x	Functionality in all DSE4510 & DSE4520 variants
x	Functionality in all DSE4520 variants
x	Functionality in DSE4510 & DSE4520 current sensing variants only
x	Functionality in DSE4510 & DSE4520 RT & RTH variants only

Configuration Parameters – Outputs (Page 4)		
401	Digital Output A Source	0 (Output Source)
402	Digital Output A Polarity	0 (Output Polarity)
403	Digital Output B Source	0 (Output Source)
404	Digital Output B Polarity	0 (Output Polarity)
405	Digital Output C Source	0 (Output Source)
406	Digital Output C Polarity	0 (Output Polarity)
407	Digital Output D Source	0 (Output Source)
408	Digital Output D Polarity	0 (Output Polarity)
409	Digital Output E Source	0 (Output Source)
410	Digital Output E Polarity	0 (Output Polarity)
411	Digital Output F Source	0 (Output Source)
412	Digital Output F Polarity	0 (Output Polarity)

7.2.5 TIMER SETTINGS

Configuration Parameters – Timers (Page 5)	
501	Mains Transient Delay
502	Start Delay
503	Preheat Timer
504	Crank Time
505	Crank Rest Time
506	Smoke Limiting
507	Smoke Limiting Off
508	Safety On Delay
509	Warm Up Time
510	Return Delay
511	Cooling Time
512	ETS Solenoid Hold
513	Failed To Stop Delay
514	Generator Transient Delay
515	Transfer Time
516	Breaker Trip Pulse
517	Breaker Close Pulse
518	Delayed Load Output 1
519	Delayed Load Output 2
520	Delayed Load Output 3
521	Delayed Load Output 4
522	Power Save Mode Delay
523	Deep Sleep Mode Delay
524	Page Timer
525	Cooling Time at Idle

7.2.6 GENERATOR SETTINGS

x	Functionality in all DSE4510 & DSE4520 variants
x	Functionality in all DSE4520 variants
x	Functionality in DSE4510 & DSE4520 current sensing variants only
x	Functionality in DSE4510 & DSE4520 RT & RTH variants only

Configuration Parameters – Generator (Page 6)		
601	Alternator Fitted	On (1), Off (0)
602	Alternator Poles	0
603	Under Voltage Shutdown Enable	On (1), Off (0)
604	Under Voltage Trip Shutdown	0 V
605	Under Voltage Warning Enable	On (1), Off (0)
606	Under Voltage Warning Trip	0 V
607	RESERVED	
608	Loading Voltage	0 V
609	Over Voltage Warning Enable	On (1), Off (0)
610	Over Voltage Warning Return	0 V
611	Over Voltage Warning Trip	0 V
612	Over Voltage Shutdown Trip	0 V
613	Under Frequency Shutdown Enable	On (1), Off (0)
614	Under Frequency Shutdown Trip	0.0 Hz
615	Under Frequency Warning Enable	On (1), Off (0)
616	Under Frequency Warning Trip	0.0 Hz
617	RESERVED	
618	Loading Frequency	0.0 Hz
619	Nominal Frequency	0.0 Hz
620	Over Frequency Warning Enable	On (1), Off (0)
621	Over Frequency Warning Return	0.0 Hz
622	Over Frequency Warning Trip	0.0 Hz
623	Over Frequency Shutdown Enable	On (1), Off (0)
624	Over Frequency Shutdown Trip	0.0 Hz
625	AC System	0 (Ac System)
626	CT Primary	0 A
627	Full Load Rating	0 A
628	Immediate Over Current Enable	On (1), Off (0)
629	Delayed Over Current Alarm Enable	On (1), Off (0)
630	Delayed Over Current Alarm Action	0 (Action)
631	Over Current Delay Time	0 s
632	Over Current Trip	0 %
633	kW Rating	0 kW
634	Over kW Protection Enable	On (1), Off (0)
635	Over kW Protection Action	0 (Action)
636	Over kW Protection Trip	0 %
637	Over kW Protection Trip Delay	0 s

7.2.7 MAINS SETTINGS

x	Functionality in all DSE4510 & DSE4520 variants
x	Functionality in all DSE4520 variants
x	Functionality in DSE4510 & DSE4520 current sensing variants only
x	Functionality in DSE4510 & DSE4520 RT & RTH variants only

Configuration Parameters – Mains (Page 7)		
701	AC System	0 (AC System)
702	Mains Failure Detection	On (1), Off (0)
703	Immediate Mains Dropout	On (1), Off (0)
704	Under Voltage Enable	On (1), Off (0)
705	Under Voltage Level	0 V
706	Under Voltage Return	0 V
707	Over Voltage Enable	On (1), Off (0)
708	Over Voltage Return	0 V
709	Over Voltage Level Trip	0 V
710	Under Frequency Enable	On (1), Off (0)
711	Under Frequency Trip	0.0 Hz
712	Under Frequency Return	0.0 Hz
713	Over Frequency Enable	On (1), Off (0)
714	Over Frequency Return	0 Hz
715	Over Frequency Trip	0.0 Hz

7.2.8 ENGINE SETTINGS

Configuration Parameters – Engine (Page 8)		
801	Start Attempts	0
802	Over Speed Overshoot	0 %
803	Over Speed Delay	0 s
804	Gas Choke Timer (Gas Engine Only)	0 s
805	Gas On Delay (Gas Engine Only)	0 s
806	Gas Ignition Off Delay (Gas Engine Only)	0 s
807	Crank Disconnect On Oil Pressure Enable	On (1), Off (0)
808	Check Oil Pressure Prior To Starting	On (1), Off (0)
809	Crank Disconnect On Oil	0.00 Bar
810	Crank Disconnect On Frequency	0.0 Hz
811	Crank Disconnect On Engine Speed	0 RPM
812	Under Speed Enable	On (1), Off (0)
813	Under Speed Trip	0 RPM
814	Over Speed Trip	0 RPM
815	Low Battery Voltage Enable	On (1), Off (0)
816	Low Battery Voltage Trip	0.0 V
817	Low Battery Voltage Return	0.0 V
818	Low Battery Voltage Delay	0:00:00
819	High Battery Voltage Enable	On (1), Off (0)
820	High Battery Voltage Return	0.0 V
821	High Battery Voltage Trip	0.0 V
822	High Battery Voltage Warning Delay	0 s
823	Charge Alt Shutdown Enable	On (1), Off (0)
824	Charge Alt Shutdown Trip	0.0 V
825	Charge Alt Shutdown Delay	0 s
826	Charge Alt Warning Enable	On (1), Off (0)
827	Charge Alt Warning Trip	0.0 V
828	Charge Alt Warning Delay	0 s
829	Low Battery Start Arming	On (1), Off (0)
830	Low Battery Start Threshold	0.0 V
831	Low Battery Start Delay	0 s
832	Low Battery Start Run Time	0 s

7.2.9 ANALOGUE INPUTS SETTINGS

Configuration Parameters – Analogue Input Settings (Page 9)		
901	Analogue Input A Sensor Type	0 (Sensor Type)
902	Analogue Input A Sensor Selection	0 (Pressure Sensor List)
903	Low Oil Pressure Enable	On (1), Off (0)
904	Low Oil Pressure Trip	0 Bar
905	Oil Pressure Sender Open Circuit	On (1), Off (0)
906	Analogue Input B Sensor Type	0 (Sensor Type)
907	Analogue Input B Sensor Selection	0 (Temperature Sensor List)
908	High Engine Temperature Trip	0.00 °C
909	Temperature Sender Open Circuit	On (1), Off (0)
910	Analogue Input C Sensor Usage	Flexible Sensor (1), Fuel Level Sensor (0)
911	Analogue Input C Sensor Type	0 (Sensor Type)
912	Analogue Input C Sensor Selection	0 (Pressure / Temperature / Percentage Sensor List)
913	Flexible Sensor C Arming	0 (Arming)
914	Flexible Sensor C Low Alarm Action	0 (Action)
915	Flexible Sensor C Low Alarm Trip	0 % / Bar / °C
916	RESERVED	
917	Flexible Sensor C Low Pre-Alarm Enable	On (1), Off (0)
918	Flexible Sensor C Low Pre-Alarm Trip	0 % / Bar / °C
919	Flexible Sensor C Low Pre-Alarm Return	0 % / Bar / °C
920	RESERVED	
921	Flexible Sensor C High Pre-Alarm Enable	On (1), Off (0)
922	Flexible Sensor C High Pre-Alarm Return	0 % / Bar / °C
923	Flexible Sensor C High Pre-Alarm Trip	0 % / Bar / °C
924-925	RESERVED	
926	Flexible Sensor C High Alarm Action	0 (Action)
927	Flexible Sensor C High Alarm Trip	0 % / Bar / °C
928-929	RESERVED	
930	Fuel Sensor C Low Shutdown Enable	On (1), Off (0)
931	Fuel Sensor C Low Shutdown Trip	0 %
932	Fuel Sensor C Low Shutdown Delay	0 s
933	Fuel Sensor C Low Pre-Alarm Enable	On (1), Off (0)
934	Fuel Sensor C Low Pre-Alarm Trip	0 %
935	Fuel Sensor C Low Pre-Alarm Return	0 %
936	Fuel Sensor C Low Pre-Alarm Delay	0 s
937	Fuel Sensor C High Pre-Alarm Enable	On (1), Off (0)
938	Fuel Sensor C High Pre-Alarm Return	0 %
939	Fuel Sensor C High Pre-Alarm Trip	0 %
940	Fuel Sensor C High Pre Alarm Delay	0 s
941	RESERVED	
942	Fuel Sensor C High Alarm Action	0 (Action)
943	Fuel Sensor C High Alarm Trip	0 %
944	Fuel Sensor C High Alarm Delay	0 s

7.2.10 SCHEDULER SETTINGS

x	Functionality in all DSE4510 & DSE4520 variants
x	Functionality in all DSE4520 variants
x	Functionality in DSE4510 & DSE4520 current sensing variants only
x	Functionality in DSE4510 & DSE4520 RT & RTH variants only

Configuration Parameters – Scheduler (Page 10)		
1001	Enable Scheduler	On (1), Off (0)
1002	Schedule Run On or Off Load	On (1), Off (0)
1003	Schedule Period	Weekly (0), Monthly (1)
1004	Scheduler (1) Start Time	0:00:00
1005	Scheduler (1) Start Day	0 (1=Monday)
1006	Scheduler (1) Start Week	1,2,3,4
1007	Scheduler (1) Duration	0:00:00
1008	Scheduler (2) Start Time	0:00:00
1009	Scheduler (2) Start Day	0 (1=Monday)
1010	Scheduler (2) Start Week	1,2,3,4
1011	Scheduler (2) Duration	0:00:00
1012	Scheduler (3) Start Time	0:00:00
1013	Scheduler (3) Start Day	0 (1=Monday)
1014	Scheduler (3) Start Week	1,2,3,4
1015	Scheduler (3) Duration	0:00:00
1016	Scheduler (4) Start Time	0:00:00
1017	Scheduler (4) Start Day	0 (1=Monday)
1018	Scheduler (4) Start Week	1,2,3,4
1019	Scheduler (4) Duration	0:00:00
1020	Scheduler (5) Start Time	0:00:00
1021	Scheduler (5) Start Day	0 (1=Monday)
1022	Scheduler (5) Start Week	1,2,3,4
1023	Scheduler (5) Duration	0:00:00
1024	Scheduler (6) Start Time	0:00:00
1025	Scheduler (6) Start Day	0 (1=Monday)
1026	Scheduler (6) Start Week	1,2,3,4
1027	Scheduler (6) Duration	0:00:00
1028	Scheduler (7) Start Time	0:00:00
1029	Scheduler (7) Start Day	0 (1=Monday)
1030	Scheduler (7) Start Week	1,2,3,4
1031	Scheduler (7) Duration	0:00:00
1032	Scheduler (8) Start Time	0:00:00
1033	Scheduler (8) Start Day	0 (1=Monday)
1034	Scheduler (8) Start Week	1,2,3,4
1035	Scheduler (8) Duration	0:00:00

7.2.11 TIME AND DATE SETTINGS

Configuration Parameters – Time (Page 11)		
1101	Time of Day	0:00:00
1102	Day of Week	0 (1=Monday)
1103	Week of Year	1-52
1104	Day of Month	1-31
1105	Month of Year	1-12
1106	Year	0-99

7.2.12 MAINTENANCE ALARM SETTINGS

Configuration Parameters – Maintenance Alarms (Page 12)		
1201	Oil Maintenance Alarm Enable	On (1), Off (0)
1202	Oil Maintenance Alarm Action	0 (Action)
1203	Oil Maintenance Alarm Engine Hours	0 h
1204	Air Maintenance Alarm Enable	On (1), Off (0)
1205	Air Maintenance Alarm Action	0 (Action)
1206	Air Maintenance Alarm Engine Hours	0 h
1207	Fuel Maintenance Alarm Enable	On (1), Off (0)
1208	Fuel Maintenance Alarm Action	0 (Action)
1209	Fuel Maintenance Alarm Engine Hours	0 h

7.2.13 ALTERNATE CONFIGURATION SETTINGS

Configuration Parameters – Alternate Configuration (Page 20)		
2001	Default Configuration	On (1), Off (0)
2002	Enable Configuration	On (1), Off (0)
2003	CAN Alternative Engine Speed	On (1), Off (0)
2004	Under Voltage Shutdown Enable	On (1), Off (0)
2005	Under Voltage Shutdown Trip	0 V
2006	Under Voltage Warning Enable	On (1), Off (0)
2007	Under Voltage Warning Trip	0 V
2008	Loading Voltage	0 V
2009	Over Voltage Warning Enable	On (1), Off (0)
2010	Over Voltage Warning Return	0 V
2011	Over Voltage Warning Trip	0 V
2012	Over Voltage Trip	0 V
2013	Under Frequency Shutdown Enable	On (1), Off (0)
2014	Under Frequency Shutdown Trip	0.0 Hz
2015	Under Frequency Warning Enable	On (1), Off (0)
2016	Under Frequency Warning Trip	0.0 Hz
2017	Loading Frequency	0.0 Hz
2018	Nominal Frequency	0.0 Hz
2019	Over Frequency Warning Enable	On (1), Off (0)
2020	Over Frequency Warning Return	0.0 Hz
2021	Over Frequency Warning Trip	0.0 Hz
2022	Over Frequency Shutdown Enable	On (1), Off (0)
2023	Over Frequency Shutdown Trip	0.0 Hz

Parameters continued overleaf...

Front Panel Configuration

x	Functionality in all DSE4510 & DSE4520 variants
x	Functionality in all DSE4520 variants
x	Functionality in DSE4510 & DSE4520 current sensing variants only
x	Functionality in DSE4510 & DSE4520 RT & RTH variants only

Configuration Parameters – Alternate Configuration (Page 20)		
2024	CT Primary	0 A
2025	Full Load Rating	0 A
2026	Immediate Over Current	On (1), Off (0)
2027	Delayed Over Current Alarm	On (1), Off (0)
2028	Delayed Over Current Alarm Action	0 (Action)
2029	Over Current Delay	00:00:00
2030	Over Current Trip	0 %
2031	Generator kW Rating	0 kW
2032	Overload Protection Enable	On (1), Off (0)
2033	Overload Protection Action	0 (Action)
2034	Overload Protection Trip	0 %
2035	Overload Protection Trip Delay	0 s
2036	AC System	0 (AC system)
2037	Mains Failure Detection	On (1), Off (0)
2038	Immediate Mains Dropout	On (1), Off (0)
2039	Mains Under Voltage Enable	On (1), Off (0)
2040	Mains Under Voltage Trip	0 V
2041	Mains Under Voltage Return	0 V
2042	Mains Over Voltage Enable	On (1), Off (0)
2043	Mains Over Voltage Return	0 V
2044	Mains Over Voltage Trip	0 V
2045	Mains Under Frequency Enable	On (1), Off (0)
2046	Mains Under Frequency Trip	0.0 Hz
2047	Mains Under Frequency Return	0.0 Hz
2048	Mains Over Frequency Enable	On (1), Off (0)
2049	Mains Over Frequency Return	0.0 Hz
2050	Mains Over Frequency Trip	0.0 Hz
2051	Under Speed Shutdown Enable	On (1), Off (0)
2052	Under Speed Shutdown Trip	0 RPM
2053	Over Speed Shutdown Trip	0 RPM

7.3 SELECTABLE PARAMETER SETTINGS

7.3.1 INPUT SOURCES

x	Functionality in all DSE4510 & DSE4520 variants
x	Functionality in all DSE4520 variants
x	Functionality in DSE4510 & DSE4520 current sensing variants only
x	Functionality in DSE4510 & DSE4520 RT & RTH variants only

INPUT SOURCES		
0	User Configured	
1	Alarm Mute	
2	Alarm Reset	
3	Alternative Configuration	
4	Auto Restore Inhibit	
5	Auto Start Inhibit	
6	Auxiliary Mains Fail	
7	Coolant Temperature Switch	
8	Emergency Stop	
9	External Panel Lock	
10	Generator Load Inhibit	
11	Lamp Test	
12	Low Fuel Level Switch	
13	Mains Load Inhibit	
14	Oil Pressure Switch	
15	Remote Start Off Load	
16	Remote Start On Load	
17	Simulate Mains Available	
18	Simulate Stop Button	
19	Simulate Auto Button	
20	Simulate Start Button	
21	Smoke Limiting	
22	Close Generator	Open Mains
23	Close Mains	Open Generator
24	Maintenance Reset Oil	
25	Maintenance Reset Air	
26	Maintenance Reset Fuel	

7.3.2 OUTPUT SOURCES

x	Functionality in all DSE4510 & DSE4520 variants
x	Functionality in all DSE4520 variants
x	Functionality in DSE4510 & DSE4520 current sensing variants only
x	Functionality in DSE4510 & DSE4520 RT & RTH variants only

OUTPUT SOURCES	
0	Not Used
1	Air Flap Relay
2	Audible Alarm
3	Battery Over Volts Warning
4	Battery Under Volts Warning
5	CAN ECU Data Fail
6	CAN ECU Error
7	CAN ECU Fail
8	CAN ECU Power
9	CAN ECU Stop
10	Charge Alternator Shutdown
11	Charge Alternator Warning
12	Close Gen Output
13	Close Gen Output Pulse
14	Close Mains Output
15	Close Mains Output Pulse
16	Combined Mains Failure
17	Common Alarm
18	Common Electrical Trip
19	Common Shutdown
20	Common Warning
21	Cooling Down
22	Digital Input A
23	Digital Input B
24	Digital Input C
25	Digital Input D
26	RESERVED
27	RESERVED
28	RESERVED
29	Emergency Stop
30	Energise To Stop
31	Fail To Start
32	Fail To Stop
33	Fuel Relay
34	Gas Choke On
35	Gas Ignition
36	Generator Available
37	Generator Over Voltage Shutdown
38	Generator Under Voltage Shutdown
39	kW Overload Alarm
40	Over Current Immediate Warning
41	Delayed Over Current Trip Alarm
42	High Coolant Temperature Shutdown
43	Low Oil Pressure Shutdown
44	Mains High Frequency
45	Mains High Voltage
46	Mains Low Frequency
47	Mains Low Voltage

More output sources overleaf...

Front Panel Configuration

x	Functionality in all DSE4510 & DSE4520 variants
x	Functionality in all DSE4520 variants
x	Functionality in DSE4510 & DSE4520 current sensing variants only
x	Functionality in DSE4510 & DSE4520 RT & RTH variants only

OUTPUT SOURCES	
48	Oil Pressure Sender Open Circuit
49	Open Gen Output
50	Open Gen Output Pulse
51	Open Mains Output
52	Open Mains Output Pulse
53	Over Frequency Shutdown
54	Over Speed Shutdown
55	Preheat During Preheat Timer
56	Preheat Until End Of Crank
57	Preheat Until End Of Safety Timer
58	Preheat Until End Of Warming
59	Smoke Limiting
60	Start Relay
61	Temperature Sender Open Circuit
62	Under Frequency Shutdown
63	Under Speed Shutdown
64	Waiting For Manual Restore
65	Flexible Sender C High Alarm
66	Flexible Sender C High Alarm
67	Flexible Sender C Low Pre-Alarm
68	Flexible Sender C Low Alarm
69	RESERVED
70	RESERVED
71	RESERVED
72	RESERVED
73	Fuel Sender High Alarm
74	Fuel Sender High Alarm
75	Fuel Sender Low Pre-Alarm
76	Fuel Sender Low Alarm
77	Load Output 1
78	Delayed Load Output 2
79	Delayed Load Output 3
80	Delayed Load Output 4
81	Air Filter Maintenance Output
82	Oil Filter Maintenance Output
83	Fuel Filter Maintenance Output
84	System In Stop Mode
85	System In Auto Mode
86	System In Manual Mode
87	RESERVED
88	Analogue Input A (Digital)
89	Analogue Input B (Digital)
90	Analogue Input C (Digital)
91	RESERVED
92	RESERVED
93	RESERVED
94	RESERVED
95	Over Speed Overshoot
96	Over Frequency Overshoot
97	Display Heater Fitted and Active

7.3.3 ALARM ACTION

ALARM ACTION	
Index	Action
0	Electrical Trip
1	Shutdown
2	Warning

7.3.4 FLEXIBLE SENSOR ALARM ACTION

FLEXIBLE SENSOR ALARM ACTION	
Index	Action
0	None
1	Shutdown
2	Electrical Trip

7.3.5 POWER UP MODE

POWER UP MODE	
Index	Mode
0	Stop
1	Manual
2	Auto

7.3.6 SENSOR TYPE

SENSOR TYPE	
Index	Type
0	None
1	Digital Input
2	Percentage Sensor
3	Pressure Sensor
4	Temperature Sensor

7.3.7 AC SYSTEM

AC SYSTEM	
Index	Type
0	2 Phase 3 Wire (L1-L2)
1	2 Phase 3 Wire (L1-L3)
2	3 Phase 3 Wire
3	3 Phase 4 Wire
4	3 Phase 4 Wire (Delta)
5	Single Phase 2 Wire

7.3.8 DIGITAL INPUT ALARM ARMING

DIGITAL INPUT ALARM ARMING	
Index	Arming
0	Always
1	From Safety On
2	From Starting
3	Never

7.3.9 DIGITAL INPUT POLARITY

DIGITAL INPUT POLARITY	
Index	Polarity
0	Close to Activate
1	Open to Activate

7.3.10 DIGITAL OUTPUT POLARITY

OUTPUT POLARITY	
Index	Polarity
0	Energise
1	De-Energise

7.3.11 FUEL UNITS

FUEL UNITS	
Index	Units
0	Litres
1	Imperial Gallons
2	US Gallons

7.3.12 PRESSURE SENSOR LIST

PRESSURE SENSOR LIST	
Index	Type
0	Not used
1	Dig Closed for Alarm
2	Dig Open for Alarm
3	VDO 5 Bar
4	VDO 10 Bar
5	Datcon 5 Bar
6	Datcon 10 Bar
7	Datcon 7 Bar
8	Murphy 7 Bar
9	CMB812
10	Veglia
11	User Defined

7.3.13 TEMPERATURE SENSOR LIST

TEMPERATURE SENOR LIST	
Index	Type
0	Not Used
1	Dig Closed for Alarm
2	Dig Open for Alarm
3	VDO 120 °C
4	Datcon High
5	Datcon Low
6	Murphy
7	Cummins
8	PT100
9	Veglia
10	Beru
11	User Defined

7.3.14 PERCENTAGE SENSOR LIST





PERCENTAGE SENSOR LIST	
Index	Type
0	Not Used
1	Dig Closed for Alarm
2	Dig Open for Alarm
3	VDO Ohm (10-180)
4	VDO Tube (90-0)
5	US Ohm (240-33)
6	GM Ohm (0-90)
7	GM Ohm (0-30)
8	Ford (73-10)
9	User Defined

8 COMMISSIONING

Before the system is started, it is recommended that the following checks are made:-

- The unit is adequately cooled and all the wiring to the module is of a standard and rating compatible with the system. Check all mechanical parts are fitted correctly and that all electrical connections (including earths) are sound.
- The unit **DC** supply is fused and connected to the battery and that it is of the correct polarity.
- The Emergency Stop input is wired to an external **normally closed** switch connected to **DC negative**.

 **NOTE: If Emergency Stop feature is not required, link the input to the DC Negative or disable the input. For further details of module configuration, refer to DSE Publication: 057-172 DSE45xx Configuration Software Manual.**

- To check the start cycle operation, take appropriate measures to prevent the engine from starting (disable the operation of the fuel solenoid). After a visual inspection to ensure it is safe to proceed, connect the battery supply. Press the *Manual/Start Mode*  button the unit start sequence will commence.
- The starter will engage and operate for the pre-set crank period. After the starter motor has attempted to start the engine for the pre-set number of attempts, the LCD will display 'Failed to start'. Press the *Stop/Reset Mode*  button to reset the unit.
- Restore the engine to operational status (reconnect the fuel solenoid). Press the *Manual/Start Mode*  button. This time the engine should start and the starter motor should disengage automatically. If not then check that the engine is fully operational (fuel available, etc.) and that the fuel solenoid is operating. The engine should now run up to operating speed. If not, and an alarm is present, check the alarm condition for validity, then check input wiring. The engine should continue to run for an indefinite period. It will be possible at this time to view the engine and alternator parameters - refer to the 'Description of Controls' section of this manual.
- Press the *Auto Mode*  button, the engine will run for the pre-set cooling down period, then stop. The generator should stay in the standby mode. If not check that there is not a signal present on the **Remote start** input.
- Initiate an automatic start by supplying the remote start signal (if configured). The start sequence will commence and the engine will run up to operational speed. Once the generator is available the delayed load outputs will activate, the Generator will accept the load. If not, check the wiring to the delayed load output contactors. Check the Warming timer has timed out.
- Remove the remote start signal. The return sequence will begin. After the pre-set time, the generator is unloaded. The generator will then run for the pre-set cooling down period, then shutdown into its standby mode.
- Set the modules internal clock/calendar to ensure correct operation of the scheduler and event logging functions. For details of this procedure see section entitled *Front Panel Configuration*
- If, despite repeated checking of the connections between the controller and the customer's system, satisfactory operation cannot be achieved, then the customer is requested to the DSE Technical Support Department

9 FAULT FINDING

9.1 STARTING

Symptom	Possible Remedy
Unit is inoperative	Check the battery and wiring to the unit. Check the DC supply. Check the DC fuse.
Read/Write configuration does not operate	
Unit shuts down	Check DC supply voltage is not above 35 Volts or below 9 Volts Check the operating temperature is not above 70°C. Check the DC fuse.
Fail to Start is activated after pre-set number of attempts to start	Check wiring of fuel solenoid. Check fuel. Check battery supply. Check battery supply is present on the Fuel output of the module. Check the speed-sensing signal is present on the module's inputs. Refer to engine manual.
Continuous starting of generator when in the <i>Auto Mode</i> 	Check that there is no signal present on the "Remote Start" input. Check configured polarity is correct. Check the mains supply is available and within configured limits
Generator fails to start on receipt of Remote Start signal.	Check Start Delay timer has timed out. Check signal is on "Remote Start" input. Confirm correct configuration of input is configured to be used as "Remote Start". Check that the oil pressure switch or sensor is indicating low oil pressure to the controller. Depending upon configuration, then set will not start if oil pressure is not low.
Pre-heat inoperative	Check wiring to engine heater plugs. Check battery supply. Check battery supply is present on the Pre-heat output of module. Check pre-heat configuration is correct.
Starter motor inoperative	Check wiring to starter solenoid. Check battery supply. Check battery supply is present on the Starter output of module. Ensure oil pressure switch or sensor is indicating the "low oil pressure" state to the controller.

9.2 LOADING

Symptom	Possible Remedy
Engine runs but generator will not take load	Check Warm up timer has timed out. Ensure generator load inhibit signal is not present on the module inputs. Check connections to the switching device. Note that the set will not take load in manual mode unless there is an active load signal.
Incorrect reading on Engine gauges	Check engine is operating correctly.
Fail to stop alarm when engine is at rest	Check that sensor is compatible with the module and that the module configuration is suited to the sensor.

9.3 ALARMS

Symptom	Possible Remedy
Low oil Pressure fault operates after engine has fired	Check engine oil pressure. Check oil pressure switch/sensor and wiring. Check configured polarity (if applicable) is correct (i.e. Normally Open or Normally Closed) or that sensor is compatible with the module and is correctly configured.
High engine temperature fault operates after engine has fired.	Check engine temperature. Check switch/sensor and wiring. Check configured polarity (if applicable) is correct (i.e. Normally Open or Normally Closed) or that sensor is compatible with the module.
Shutdown fault operates	Check relevant switch and wiring of fault indicated on LCD display. Check configuration of input.
Electrical Trip fault operates	Check relevant switch and wiring of fault indicated on LCD display. Check configuration of input.
Warning fault operates	Check relevant switch and wiring of fault indicated on LCD display. Check configuration of input.
CAN ECU WARNING CAN ECU SHUTDOWN	This indicates a fault condition detected by the engine ECU and transmitted to the DSE controller.
CAN DATA FAIL	Indicates failure of the CAN data link to the engine ECU. Check all wiring and termination resistors (if required).
Incorrect reading on Engine gauges	Check engine is operating correctly. Check sensor and wiring paying particular attention to the wiring to terminal 10 (refer to appendix).
Fail to stop alarm when engine is at rest	Check that sensor is compatible with the module and that the module configuration is suited to the sensor.

9.4 COMMUNICATIONS

Symptom	Possible Remedy
CAN DATA FAIL	Indicates failure of the CAN data link to the engine ECU. Check all wiring and termination resistors (if required).

9.5 INSTRUMENTS

Symptom	Possible Remedy
Inaccurate generator measurements on controller display	<p>Check that the CT primary, CT secondary and VT ratio settings are correct for the application.</p> <p>Check that the CTs are wired correctly with regards to the direction of current flow (p1,p2 and s1,s2) and additionally ensure that CTs are connected to the correct phase (errors will occur if CT1 is connected to phase 2).</p> <p>Remember to consider the power factor ($kW = kVA \times \text{powerfactor}$).</p> <p>The controller is true RMS measuring so gives more accurate display when compared with an 'averaging' meter such as an analogue panel meter or some lower specified digital multimeters.</p> <p>Accuracy of the controller is better than 1% of full scale. Generator voltage full scale is 415V ph-N, accuracy is $\pm 4.15V$ (1% of 415V).</p>

9.6 MISCELLANEOUS

Symptom	Possible Remedy
Module appears to 'revert' to an earlier configuration	<p>When editing a configuration using the PC software it is vital that the configuration is first 'read' from the controller before editing it. This edited configuration must then be "written" back to the controller for the changes to take effect.</p> <p>When editing a configuration using the fascia editor, be sure to press the the <i>Auto Mode</i>  (✓) button to save the change before moving to another item or exiting the fascia editor</p>

 **NOTE: The above fault finding is provided as a guide check-list only. As the module can be configured to provide a wide range of different features, always refer to the source of your module configuration if in doubt.**

10 MAINTENANCE, SPARES, REPAIR AND SERVICING

The controller is *Fit and Forget*. As such, there are no user serviceable parts within the controller. In the case of malfunction, you should contact your original equipment manufacturer (OEM).

10.1 PURCHASING ADDITIONAL CONNECTOR PLUGS FROM DSE

If you require additional plugs from DSE, please contact our Sales department using the part numbers below.

10.1.1 PACK OF PLUGS

Module Type	Plug Pack Part Number
4510-01	100-400-41
4520-01	100-400-42
4510-02, 4510-03 & 4510-04	100-400-47
4520-02, 4520-03 & 4520-04	100-400-46

10.1.2 INDIVIDUAL PLUGS

Module Terminal Designation	Plug Description	Part No.
1-9	DSE4520 Only 9 way 5.08mm	007-166
1-7	DSE4510 Only 7 way 5.08mm	007-155
10-20	11 way 5.08mm	007-451
21-24	4 way 10.16mm	007-003
25-28	DSE4520 Only 4 way 10.16mm	007-003
29-32	Not fitted on 45xx-01 4 way 5.08mm	007-282
	PC Configuration interface lead (USB type A – USB type B)	016-125

10.2 PURCHASING ADDITIONAL FIXING CLIPS FROM DSE

Item	Description	Part No.
	Module Fixing Clips (Packet Of 2)	020-406

10.3 PURCHASING ADDITIONAL SEALING GASKET FROM DSE

Item	Description	Part No.
	Module Silicon Sealing Gasket	020-282

11 WARRANTY

DSE provides limited warranty to the equipment purchaser at the point of sale. For full details of any applicable warranty, you are referred to your original equipment supplier (OEM).

12 DISPOSAL

12.1 WEEE (WASTE ELECTRICAL AND ELECTRONIC EQUIPMENT)

Directive 2002/96/EC

If you use electrical and electronic equipment you must store, collect, treat, recycle and dispose of WEEE separately from your other waste.



12.2 ROHS (RESTRICTION OF HAZARDOUS SUBSTANCES)

Directive 2002/95/EC: 2006

To remove specified hazardous substances (Lead, Mercury, Hexavalent Chromium, Cadmium, PBB & PBDE's)

Exemption Note: Category 9. (Monitoring & Control Instruments) as defined in Annex 1B of the WEEE directive will be exempt from the RoHS legislation. This was confirmed in the August 2005 UK's Department of Trade and Industry RoHS REGULATIONS Guide (Para 11).

Despite this exemption, DSE has been carefully removing all non RoHS compliant components from our supply chain and products.

When this is completed, a Lead Free & RoHS compatible manufacturing process will be phased into DSE production.

This process that is almost complete and is being phased through different product groups.

This Page is Intentionally Left Blank

This Page is Intentionally Left Blank